

# Town & Country INDUSTRIES

Wholesale Aluminum and Building Products



## PRODUCTS CATALOG

Pool & Patio • Pergola • Windows & Doors • Fencing & Railing • Decking  
Siding, Soffit & Accessories • Gutters • Storm Protection

# Locations

**36**  
**LOCATIONS**  
TO BETTER SERVE YOU



## Alabama

**Mobile** | 1516 Azalea Rd | 251-660-1449

## Florida

**Cape Coral** | 1404 Viscaya Pkwy, Unit 1 | 239-574-5999

**Casselberry** | 370 W Lemon Ln | 407-834-6633

**Daytona Beach** | 433 Walker St Ste 3A | 386-254-7927

**Fort Lauderdale\*** | 400 W McNab Rd | 954-970-9999

**Fort Myers** | 6301 Metro Plex Dr | 239-337-9400

**Fort Pierce** | 3800 Crossroads Pkwy | 772-465-5044

**Gainesville** | 605 NW 53rd Ave Ste A1 | 352-376-0111

**Hudson** | 16748 Scheer Blvd | 727-862-5483

**Jacksonville** | 8215 Westside Industrial Dr, Ste 200 | 904-764-7089

**Jacksonville\*** | 6746 Stuart Ave | 904-765-5503

**Lakeland** | 2950 Maine Ave, Bays 6-8 | 863-606-0005

**Largo** | 6750 Cross Bayou Dr | 727-546-4631

**Lecanto** | 2988 W Gulf To Lake Hwy | 352-746-0808

**Miami** | 2751 NW 73rd St | 305-836-4688

**Naples** | 4227 Enterprise Ave STE J1 | 239-261-4401

**North Port** | 4889 Plantation Blvd, Ste 8 | 941-624-5006

**Ocala** | 115 SW 49th Ave, Ste 101 | 352-351-8533

**Orlando** | 4311 Shader Rd Ste 100 | 407-292-1517

**Pensacola** | 9310 Waring Rd | 850-479-1662

**Pensacola\*** | 100 W Herman St | 850-438-8280

**Riviera Beach** | 3900 Fiscal Ct, Ste 700 | 561-863-8172

**Rockledge** | 1950 Murrell Rd STE 10 | 321-632-0920

**Sarasota** | 2320 Industrial Blvd | 941-355-7627

**Tampa\*** | 9808 E Broadway Ave | 813-626-7784

**Tampa** | 5300 Adamo Dr, Ste G | 813-621-0512

**Venice** | 215 Center Ct | 941-497-3943

**W Melbourne** | 7300 Technology Dr, Ste D | 321-723-0051

**West Palm Beach** | 605 Roseland Dr Ste B | 561-833-2407

## Georgia

**Columbus** | 5224 Miller Rd, Ste B1 | 706-569-9464

**Marietta** | 1811 W Oak Pkwy, Ste B | 770-428-1986

**Pooler** | 5240 Old Louisville Rd BLDG 44 | 912-330-9004

## North Carolina

**Clayton\*** | 853 Shotwell Rd | 919-243-6444

## South Carolina

**Columbia\*** | 195 Shop Grove Dr, Ste B | 803-695-6184

## Tennessee

**LaVergne\*** | 270 Mason Rd | 615-903-3717

## Texas

**Houston\*** | 16580 Air Center Blvd | 713-688-3370

# Introduction

## About Us

In April of 2005, Town & Country Industries joined the ABC Supply family, and together we are the largest wholesale distributor of roofing, windows, gutters, siding, hurricane protection and aluminum building products in the United States.

Since our start in 1982, we've grown to become a national organization with more than 900 branches and other facilities in North America. Our success is the result of an unwavering focus on a single, simple guiding principle - treat contractors (large and small) with respect and give them the products and services they need to build their businesses. We offer high quality products, superior service and competitive pricing, ensuring the contractors have the products they need - when and where they need them.



# Index

- About Us** ..... 1
- Index** ..... 2
- Pool & Patio**..... 4
  - Patio Extrusions..... 4
  - EZ Screen ..... 15
  - Large Opening Enclosures..... 16
  - Angles..... 16
  - Clips ..... 17
  - Channels..... 17
  - Aluminum Roofing Products ..... 19
  - HR Railing Section ..... 28
  - Castings..... 30
  - Phifer Screen & Spline ..... 32
  - Window Screen Frames..... 36
  - Screen Tools..... 37
  - Ultra Barrier..... 37
  - Screen Doors..... 38
  - Doorjamb & Frame Extrusions..... 39
  - Door Accessories..... 41
  - Door Grills..... 43
  - Pet Doors ..... 43
  - Screen Doors & Accessories..... 44
  - T&C-Ultracote 410 Stainless Steel Screws..... 50
  - T&C-Ultracote Carbon Steel Screws..... 51
  - Anchors..... 53
  - Rivets ..... 53
  - Lag Screws..... 53
  - Extensions ..... 53
  - Drill Bits ..... 54
  - Cable Ties ..... 54
  - Tape..... 54
  - Caulking ..... 55
  - Drivers ..... 56, 57 & 169
  - T&C Ultradrive ..... 57
  - Deco Bahama Shutters..... 58
  - Shade Awnings Non-Code ..... 60
- Windows & Doors**..... 61
- Pergola**..... 62
  - Elitewood™ Ultra Series ..... 62
  - Elitewood™ Classic Series ..... 64
  - Naturewood Pergola..... 66
- Fencing & Railing** ..... 71
- Decking** ..... 72
- Siding, Soffit & Accessories**..... 73
  - Contractors Choice..... 73
  - ClimaForce High Performance Foam Insulated Siding..... 74
  - Ashton Heights ..... 75
  - Camden Pointe..... 76
  - Vortex Extreme..... 77

Soffit.....	78
Channel, Trim & Cornerpost.....	79
Accessories.....	81
Gable Vents & J-Blocks.....	83
Aluminum Soffit.....	85
Aluminum Fascia .....	86
Aluminum Channels .....	87
Aluminum Drip Edge.....	89
James Hardie Fiber Cement Siding & Trim.....	91
Allura Fiber Cement Siding & Trim.....	96
Everlast Composite Siding & Trim.....	102
Stone Veneer .....	106
<b>Rainware .....</b>	<b>107</b>
Rainware Components .....	107
Gutters.....	108
Downspouts.....	109
Elbows.....	110
Variable Degree Elbows .....	111
Offsets.....	112
Downspout Accessories .....	113
Miters.....	114
Expansion Joints & End Caps.....	116
Hangers .....	117
Rainware Accessories.....	118
Round Products.....	119
Half Round Products .....	121
Screen Systems.....	123
Perforated & Dome.....	124
Gutter Protection.....	126
Coil.....	128
<b>Hurricane Protection .....</b>	<b>130</b>
Wind-Borne Debris Map.....	130
Storm Panel Coverage.....	132
2" Storm Panels.....	134
Storm Panels Accessories & Extrusions.....	135
Storm Panel Coil.....	138
Accordion Shutters.....	139
Accordion Spread Sheets.....	144
Accordion Shutter Accessories .....	151
Fullview UltraView Bahama & E.A. Colonial.....	154
Painted Angles .....	161
Architectural Angles.....	162
Structural Angles.....	163
Painted Tubes .....	164
Rectangular Tubes.....	165
Square Tubes.....	166
Anchors.....	167
Concrete Screws .....	167
Rivets - Lags - Studs .....	168
Screws.....	168
Washers.....	170
Drill Bits .....	170
Drivers .....	58, 59 & 171
Eyewall Armor Fabric And Clip.....	172

# Pool & Patio

## Patio Extrusions

### 1" x 2" Open Back Patio (Flat Spline) .40 min

Color	19' 6"	21'	24'	30'
White	1006319	1006321	1006324	1006330
Bronze	1006219	1006221	1006224	1006230
Anodized		1006121		
Driftwood			1006424	
Adobe			1006524	
Ivory			1006624	
Almond			1006724	
Wheat			1006824	
Black			1006924	

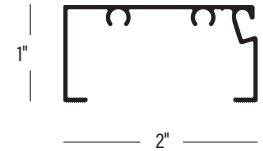

### 1" x 3" Open Back Patio (Flat Spline)

Color	20'	24'	30'
White		1356324	1356330
Bronze		1356224	1356230
Tan		1356024	
MF		13560MF	
Driftwood		1356424	
Clay		1356524	
Ivory		1356624	
Wheat		1356724	
Almond		1356824	
Black		1356924B	
Sand	1356920		

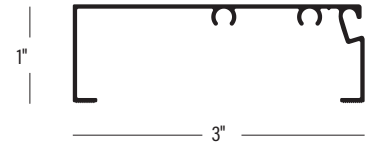

### 1/2" x 1" Archway (Flat Spline)

Color	24"
White	1350324
Bronze	1350224



### 1/2" x 2" Archway (Flat Spline)

Color	24"
White	1352324
Bronze	1352224

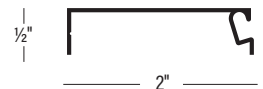

### 2" x 2" Patio (Flat Spline) .40 min

Color	19' 6"	21'	24'	30'
White	1016319	1016321	1016324	1016330
Bronze	1016219	1016221	1016224	1016230
Anodized		1016121		
Driftwood			1016424	
Clay			1016524	
Ivory			1016624	
Wheat			1016824	
Almond			1016724	
Black			1016924	

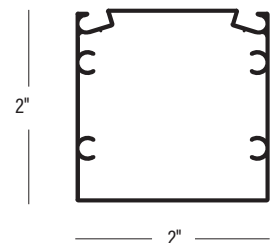

### 2" x 3" Patio (Flat Spline) .45 min

Color	16'	18'	18.5'	19.5'	21'	24'	30'
White	1358316		13583186	1358319	1358321	1358324	1358330
Bronze	1358216		13582186	1358219	1358221	1358224	1358230
Tan						1358024	
Driftwood						1358424	
Clay						1358524	
Ivory						1358624	
Wheat						1358724	
Almond						1358824	
Black						1358924B	
Sand		1358918					

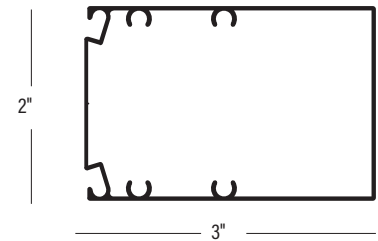

### 2" x 3" Patio (Flat Spline) .70 min

Color	24'
White	1360324

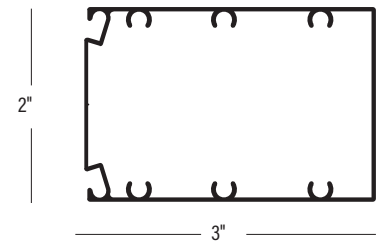

### 3" x 2" Patio (Flat Spline) .45 min

Color	24'	30'
White	1366324	1366330
Bronze	1366224	1366230
Driftwood	1366424	
Ivory	1366624	
Wheat	1366724	

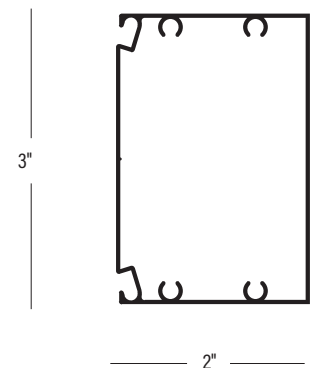

# Pool & Patio

## 2" x 4" Patio (Flat Spline) .045 min

Color	24'	30'
White	1364324	1364330
Bronze	1364224	1364230
Tan	1364024	
Driftwood	1364424	
Ivory	1364624	
Wheat	1364724	

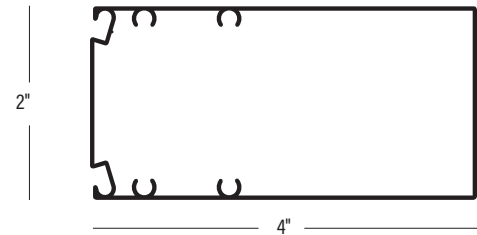

## 2" x 3" Special Post (Flat Spline) .045 min

Color	24'	30'
White	1362324	1362330
Bronze	1362224	1362230
Driftwood	1362424	
Ivory	1362624	

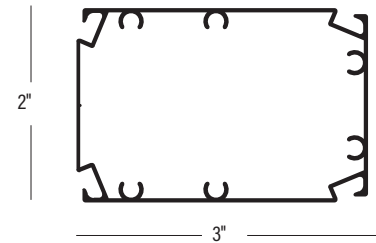

## 2" x 4" Tilt Beam (Flat Spline) .050 min

Color	20'	24'	30'
White	1365320	1365324	1365330
Bronze		1365224	1365230
Driftwood		1365424	1365430
Clay		1365524	
Ivory	1365620	1365624	1365630
Wheat		1365724	

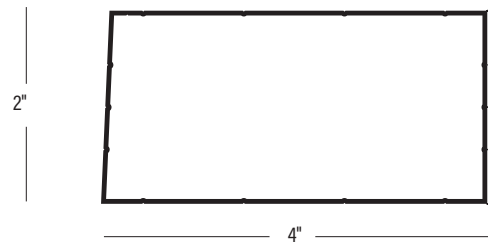

## 2" x 5" Patio .50 min

Color	24'	30'
White	1363324	1363330
Bronze	1363224	1363230
Clay		1363430
Ivory	1363624	

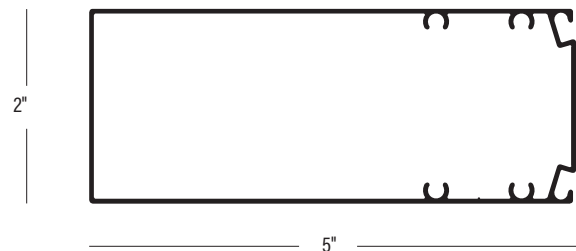

### Texan Tilt Beam - 24ft

White	Ivory	Almond	Bronze	Clay
1367324**	1367624	1367824	136724	1367424
<i>* Available in Houston, TX only</i>				
<i>** Accepts 3" Post Material</i>				

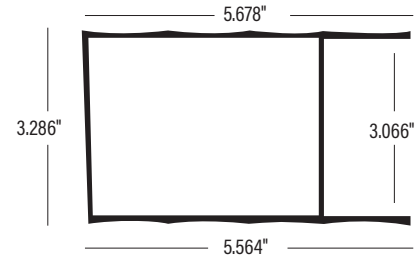

### 3" x 3" Fluted Post

Color	8'	9'	10'	12'	24'	30'
White	1114308	1114309	1114310	1114312	1114324	1114330
Ivory			11146810		11146824	
Almond			1114810		1114824	
Bronze	1114208	1114209	1114210	1114212	1114224	1114230
Driftwood			1114410		1114424	
Clay					1114524	1114530
Ivory			1114610		1114624	
Wheat					1114724	1114730

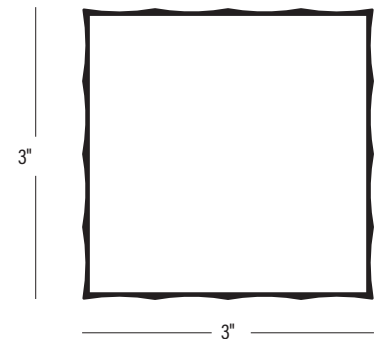

### 1" x 2" Patio with V Groove for Kick Plate

Size	White	Bronze	Wheat	Black
24'	1006324vg	1006224vg	1006824vg	1006924vg

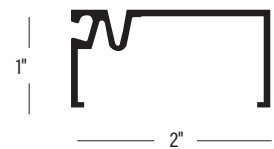

### 2" x 2" Patio with V Groove for Kick Plate

Size	White	Bronze	Clay	Wheat	Black
24'	1016324vg	1016224vg	1016524vg	1016824vg	1016924vg

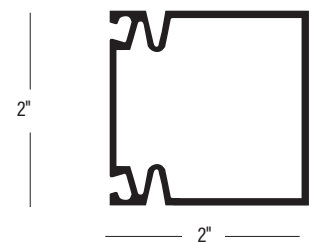

# Pool & Patio

## 3" x 3" Square Tube (.093)

Size	8'	9'	10'	12'	20'	24'	30'
White	1116308	1116309	1116310	1116312	1116320	1116324	1116330
Bronze	1116208	1116209	1116210		1116220	1116224	1116230
Driftwood						1116424	
Clay						1116524	1116530
Ivy						1116624	
Wheat						1116724	1116730
Black						1116924B	

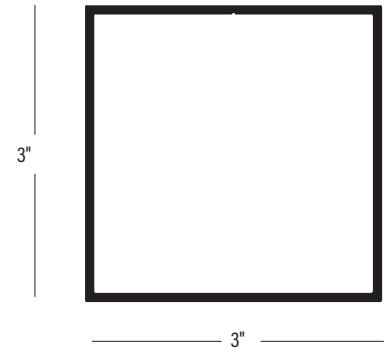

## 3" x 3" Square Tube (.125)

Size	24'	30'
White	1118324	1118330
Bronze	1118224	1118230
Ivory	1118624	
Almond	1118824	

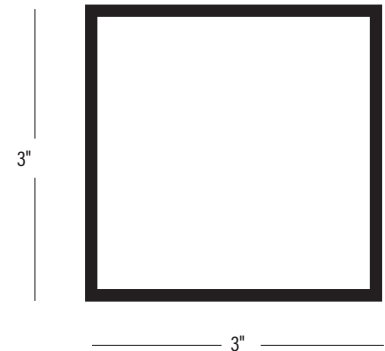

## 3"x3" EAV Rail (.060)

Size	24'	30'
White	1021324	1021330
Bronze	1021224	1021230

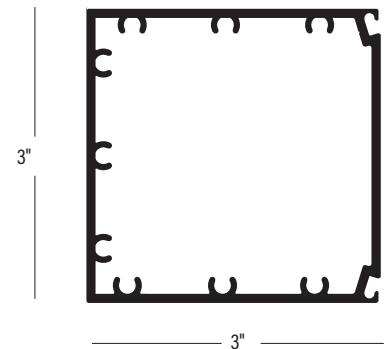

### 4" x 4" Square Tube (.125)

Size	10'	12'	20'	24'	30'
White	1120310	1120312	1120320	1120324	1120330
Bronze	1120210	1120212	1120220	1120224	1120230
Clay					1120530
Wheat					1120730

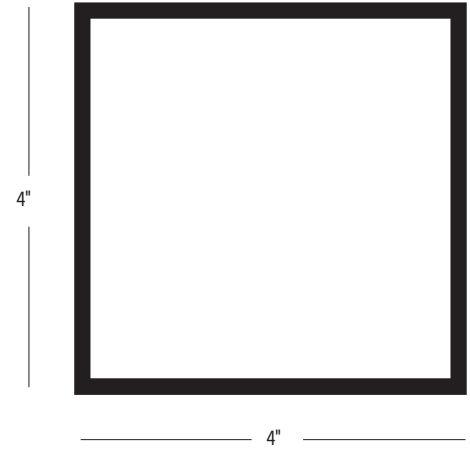

### 4" x 4" Patio with 3 Spline Grooves (.125)

Size	24'	30'
White	1123230	1123330
Bronze	1123224	1123230

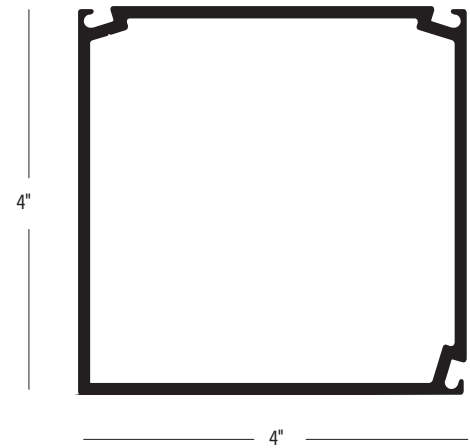

# Pool & Patio

## 6" x 6" Patio with 3 Spline Grooves (.125)

Size	20'	24'
White	1131320	1131324
Bronze	1131220	1131230

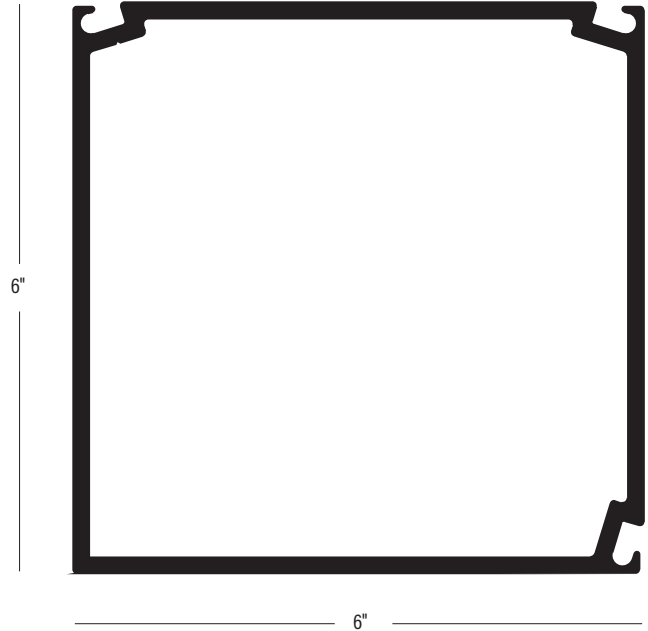

## 3" x 3" Patio with 4 Spline Grooves (.118)

Size	White	Bronze	Clay	Wheat
24'	1024324	1024224	1024524	1024824

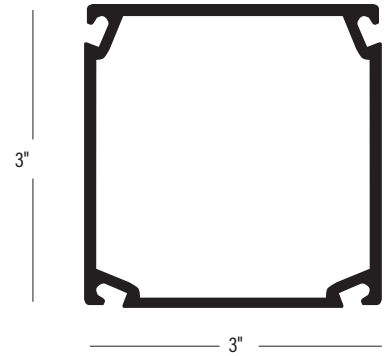

## 2" x 2" Patio with 4 Spline Grooves (.118)

Size	White	Bronze	Clay	Wheat	Black
24'	1028324	1028224	1028424	1028724	1028924

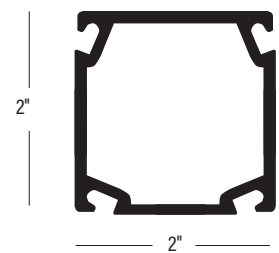

### 1" x 4" Self-Mating Beam (lap)

Size	White	Bronze
16' (.046)	1060316	1060216
18' (.046)	1060318	1060218
20' (.046)	1060320	1060220
22' (.046)	1060322	1060222
24' (.046)	1060324	1060224
26' (.046)	1060326	1060226
28' (.046)	1060328	1060228
30' (.046)	1060330	1060230

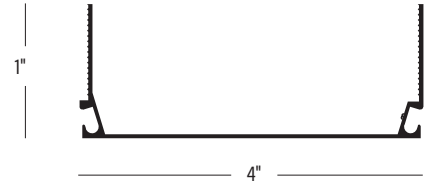

### 1" x 5" Self-Mating Beam (lap)

Size	White	Bronze
16' (.050)	1061316	1061216
18' (.050)	1061318	1061218
20' (.050)	1061320	1061220
22' (.050)	1061322	1061222
24' (.050)	1061324	1061224
26' (.050)	1061326	1061226
28' (.050)	1061328	1061228
30' (.050)	1061330	1061230

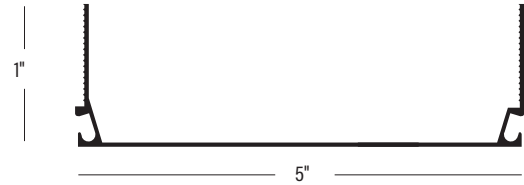

### 1" x 6" Self-Mating Beam (lap)

Size	White	Bronze	Clay	Ivory
16' (.050)	1062316	1062216		
18' (.050)	1062318	1062218		
20' (.050)	1062320	1062220		
22' (.050)	1062322	1062222		
24' (.050)	1062324	1062224		1062624
26' (.050)	1062326	1062226		
28' (.050)	1062328	1062228		
30' (.050)	1062330	1062230	1062430	
34' (.050)	1062334			



# Pool & Patio

## 1" x 7" Self-Mating Beam (lap)

Size	White	Bronze	Clay	Ivory	Almond	Wheat
18' (.055)	1064318	1064218				
20' (.055)	1064320	1064220				
22' (.055)	1064322	1064222				
24' (.055)	1064324	1064224		1064624	1064524	1064724
26' (.055)	1064326	1064226				
28' (.055)	1064328	1064228				
30' (.055)	1064330	1064230	1064430	1064630	1064530	1064730
32' (.055)	1064332	1064232				
34' (.055)	1064334	1064234				

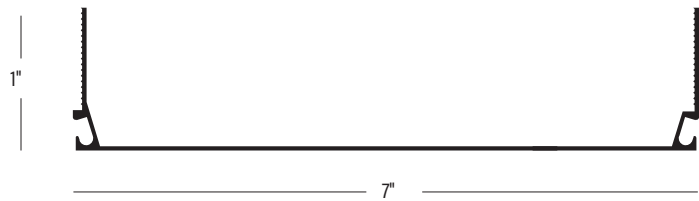

## 1" x 8" Self-Mating Beam (lap)

Size	White	Bronze	Clay	Wheat
16' (.072)	1066316	1066216		
18' (.072)	1066318	1066218		
20' (.072)	1066320	1066220		
22' (.072)	1066322	1066222		
24' (.072)	1066324	1066224		
26' (.072)	1066326	1066226		
28' (.072)	1066328	1066228		
30' (.072)	1066330	1066230	1066430	1066830
32' (.072)	1066332	1066232		
34' (.072)	1066334	1066234		
36' (.072)	1066334	1066236		
40' (.072)	1066340	1066240		

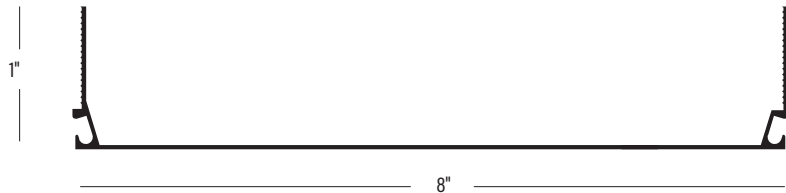

### 1" x 9" Self-Mating Beam (lap)

Size	White	Bronze	Clay	Wheat
18'(.072)	1068318	1068218		
20'(.072)	1068320	1068220		
22'(.072)	1068322			
24'(.072)	1068324	1068224		
26'(.072)	1068326	1068226		
28'(.072)	1068328	1068228		
30'(.072)	1068330	1068230	1068430	1066830
32'(.072)	1068332	1068232		
34'(.072)	1068334	1068234		
36'(.072)	1068336	1068236		
38'(.072)	1068338	1068238		
40'(.072)	1068340	1068240		

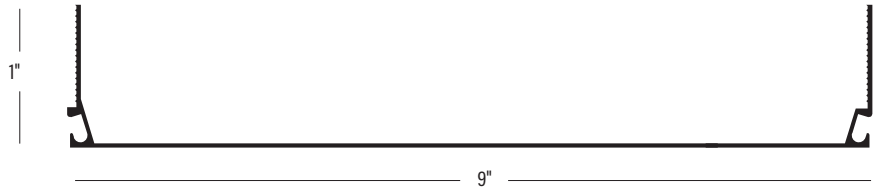

### 1" x 10" Self-Mating Beam (lap)

Size	White	Bronze
20' (.092)	1070320	1070220
22' (.092)	1070322	1070222
24' (.092)	1070324	1070224
26' (.092)	1070326	1070226
28' (.092)	1070228	1070228
30' (.092)	1070330	1070230
32' (.092)	1070332	1070232
36' (.092)	1070336	1070236
38' (.092)	1070338	1070238
40' (.092)	1070340	1070240

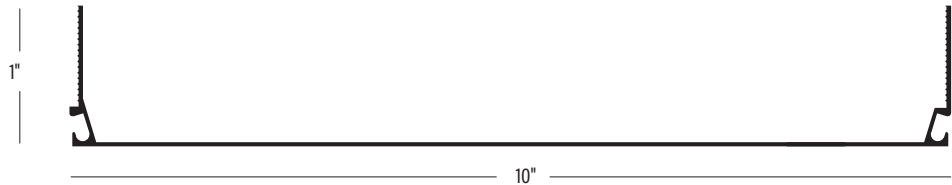

# Pool & Patio

## 3" x 3" Eave Rail

Size	White	Bronze
24' (.060)	1021324	1021224
30' (.072)	1021330	1021230

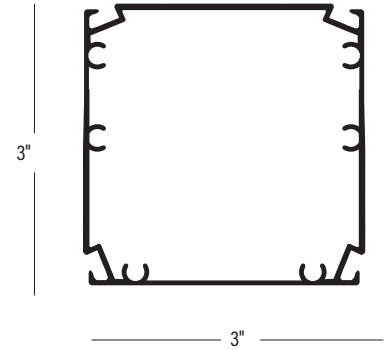

## 1" x 2" Self-Mating Snap

Size	White	Bronze	Black
25' (.045)	1032325	1032225	1032925
24' (.045)	1032324	1032224	

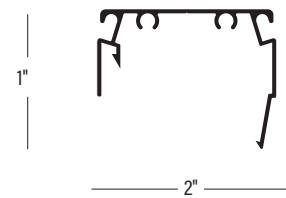

## 1" x 3" Self-Mating Snap

Size	White	Bronze
25' (.045)	1042325	1042225
24' (.045)		1042224

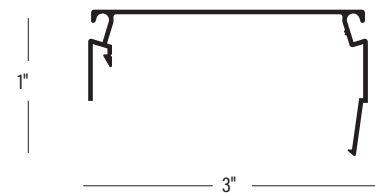

## 1" x 4" Self-Mating Snap

Size	White	Bronze
25' (.045)	1044325	1044225
30' (.045)		1044230

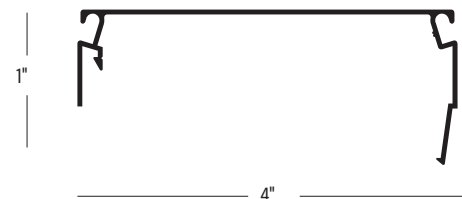

## 1" x 5" Self-Mating Snap

Size	Bronze
25' (.045)	1045225

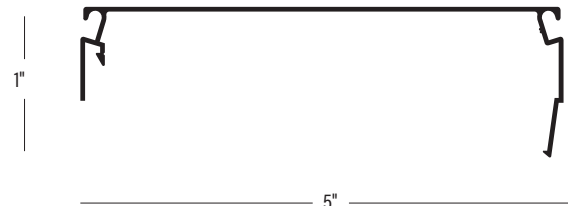

### 1" x 2" Perimeter Snap

Size	White	Bronze
24' (.040)	1031324	
30' (.040)	1031330	1031230

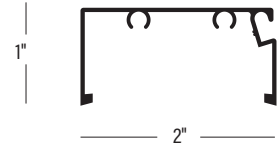

### 2" x 2" Perimeter Snap

Size	White	Bronze
30' (.040)	1037330	1037230

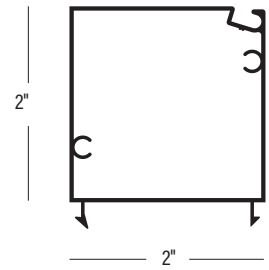

### 2" x 2" Universal Perimeter Snap

Size	White	Bronze
24' (.040)	1041324	1041224
30' (.040)	1041330	1041230

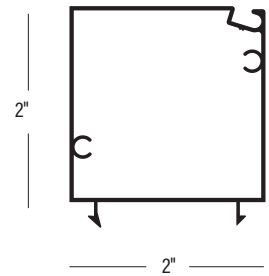

## EZ Screen

### 1½" EX Screen

Length	Bronze	White
24.00	EZSCB24	EZSCW24

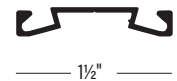

### 3½" EX Screen

Length	Bronze	White
24.00	EZS3B24	EZS3W24

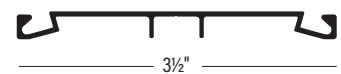

# Pool & Patio

## Large Opening Enclosures



*Check your local branch for availability*

## Angles

### Angles

Description	White	Bronze	Ivory	Clay	Driftwood	Wheat	Sand
½" x ½" Angle - 20'	1080320	1080220					
¾" x ¾" x ¼" Angle - 20'	1084320	1084220					
1" x 1" x ¼" Angle - 20'	1088320	1088220	1088620	1088520	1088420	1088720	
1½" x 1½" x ¼" Angle - 24'	1089324		1089624				1089924
1" x 2" x ¼" Angle - 20'	1090320	1090220					
1" x 3" x ¼" Angle - 20'	1092320	1092220					
2" x 2" x ⅜" Angle - 20.25'	1094320	1094220					
1" x 5" x ⅛" Angle - 20'	1097320	1097220					
2" x 2" x ⅛" Angle - 20'	5032320	5032220					
2" x 3" x ⅛" Arch Angle - 20'	5074320	5074220					
2" x 4" x ⅛" Angle - 20'	5076320	5076220					
2" x 5" x ⅛" Arch Angle - 20'	5080320	5080220					

# Clips

## Clips

Description	White	Bronze	Mill Finish	Driftwood	Ivory
Angle Clips 2" x 2" x 2" 3 Hole	2718303	2718203			
Angle Clips 2" x 2" x 2" 4 Hole	2718304	2718204			
Angle Clips 2" x 2" x 2" 6 Hole	2718306	2718206			
Capri Clips 1" x 1" x 2" w/4 Prepunched Holes	2722300	2722200		2722400	2722600
Capri Clips 1" x 1" x 3" w/4 Prepunched Holes	2722303	2722203		2722403	2722603
Internal Clip (2)			2724000		
3 Internal Post Insert			2724001		
3 Internal Post Insert w/Ears			2724002		
4 Internal Post Insert			LP13950		
4 Internal Post Insert w/Ears			LP14040		
4 Internal Post Insert 3 Spline			LP13951		
Castle Clip	2720300	2720200			

# Channels

## 1" x 2 1/8" x 1" Receiving Channel

Color	20' (.045)	24' (.045)
White	1130320	1130324
Bronze	1130220	1130224
Driftwood		1130424
Clay		1130524
Ivory		1130624
Almond		1130724
Wheat		1130924

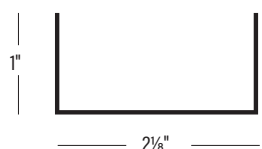

## 1/2" x 2 1/8" x 1 1/2" Receiving Channel

Color	20' (.040)	24' (.040)
White	1132320	1132324
Bronze	1132220	1132224
Driftwood		1132424
Clay		1132524
Ivory		1132624
Black		1132924
Wheat		1132824



# Pool & Patio

## 1 1/2" x 3 1/8" x 1 1/2" Receiving Channel

Color	20' (.040)	24' (.040)
White	1134320	1134324
Bronze	1134220	1134224
Driftwood		1134424
Clay		1134524
Ivory		1134624
Black		1134924B
Wheat		1134924
Almond		1134724

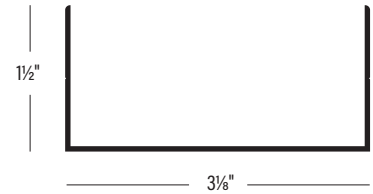

## 1 1/2" x 4 1/8" x 1 1/2" Receiving Channel

Color	24' (.055)
White	1135324
Bronze	1135224

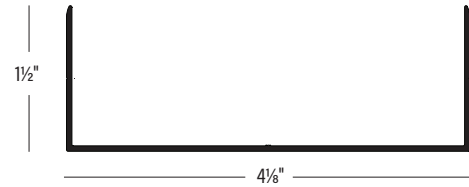

## 2" x 2 1/4" x 2" Receiving Channel

Color	12'
White	1135312
Bronze	1135212

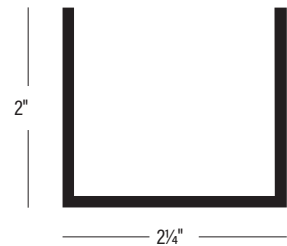

## 5/8" x 2" x 5/8" Receiving Channel

Color	24'
White	1129324
Bronze	1129224
Wheat	1129724
Clay	1129524
Black	1129924

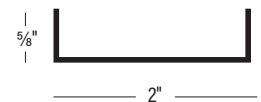

## 5/8" x 3" x 5/8" Receiving Channel

Color	24'
White	1128324
Bronze	1128224
Wheat	1128724
Clay	1128524
Black	1128924
Driftwood	1128424

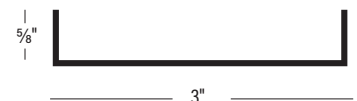

## 1 1/8" x 3/4" x .060 U-Channel

Color	20'
White	1202320
Bronze	1202220
Wheat	1202820
Clay	1202520
Black	1202920

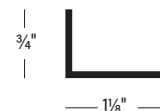

## Aluminum Roofing Products

### Roll Form Gutter (.024")

Color	Part #
White	2880300
Ivory	2880600
Bronze	2880200
White Cedar Embossed	2880130
Ivory Cedar Embossed	2880140
Bronze Cedar Embossed	2880120
Clay Cedar Embossed	2880100
Brown Cedar Embossed	2880150



### Roll Form Valance (.024")

Color	Part #
White	2878300
Ivory	2878600
Bronze	2878200
White Cedar Embossed	2878130
Ivory Cedar Embossed	2878140
Bronze Cedar Embossed	2878120
Clay Cedar Embossed	2878100
Brown Cedar Embossed	2878150



### Extruded Surround Gutter

Description	White	Wheat	Bronze
20' Extruded Surround Gutter	1317320		
24' Extruded Surround Gutter	1317324	1317824	1317224



# Pool & Patio

## Surround Gutter Corner

Description	White	Wheat	Bronze
Surround Gutter Corner	1317300cn	1317800cn	1317200cn



## Interlocking Roof Pans(sold in lineal feet)

Description	White	Ivory	Driftwood
2 Rib .024 3" Interlocking Roof Pans	2780300		
5 Rib .024 3" Interlocking Roof Pans	2782300		
2 Rib .030 3" Interlocking Roof Pans	2788300		
5 Rib .030 3" Interlocking Roof Pans	2790300		

*Special Note: Other colors and embossed coils may be available*

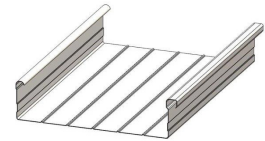

## Perimeter Angle (.40)

Description	Part #
1" x 4" x 12 ft White	2866000
2" x 3" x 12 ft White	LP07070



## Interlocking Roof Over Pans .024 - 1 1/4"

Part #	Color
2766300	White

*Special Note: Other colors may be available*



## Protector Panels

Description	Part #	Color
.014 Protector Panels	2796300	White
.019 Protector Panels	2796302	White
.024 Protector Panels	2796301	White
Protector Panel End Cap	2799000	White



## 1 7/8" Wide Foam Insulation (Square Cut)

Description	Part #	Color
1 1/4" Thick	2910000	White
1 1/2" Thick	2911000	White
2" Thick	2912000	White

### 11 7/8" Wide Foam Insulation (Notched)

Description	Part #	Color
2" Thick	2914000	White
2 1/2" Thick	2916000	White
3" Thick	2918000	White

### Polystyrene Insulation

Description	Part #	Color
2" x 4 ft x 12 ft Plain Foam	2902000	White
2" x 4 ft x 12 ft Foil One-Side Foam	2904000	White
2" x 4 ft x 12 ft Foil Two-Side Foam	2906000	White

### Foam Inserts

Description	Part #	Color
2" x 3" x 12"	2900000	White

### Insulated Roof Panels

#### Description

- 2" Polystyrene Panels Special Order
- 3" Polystyrene Panels Available in most locations in lengths of 8' - 18'  
*Panel widths available: 4' Wide, 2' Wide and 4' Wide with Fanbeam Center*
- 4" Polystyrene Panels Special Order
- 6" Polystyrene Panels Special Order

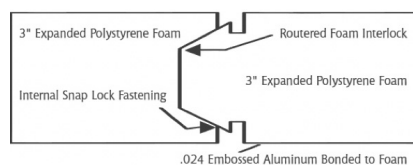

### 3" Extruded Header

Size	White	Bronze	Driftwood	Clay	Ivory	Wheat	Almond
20'	1330320	1330220					
24'	1330324	1330224	1330424	1330524	1330624	1330724	1330924
30'	1330330	1330230	1330430	1330530	1330630	1330730	

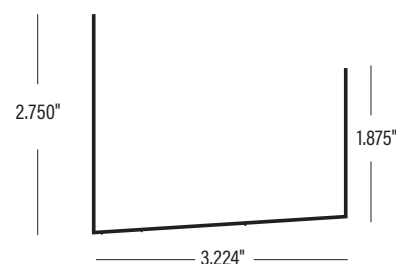

Sizes, Colors & Availability May Vary By Location

# Pool & Patio

## 3" Adjustable Pitch Header Top

Size	White	Bronze	Clay	Wheat
24'	2868324	2868224	2868524	2868824

*Used with 3" adjustable pitch header receiver*

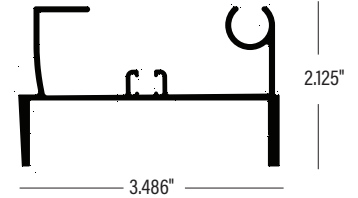

## 3" Adjustable Pitch Header Receiver

Size	White	Bronze	Clay	Wheat
24'	2869324	2869224	2869524	2869824

*Used with 3" adjustable pitch header top*

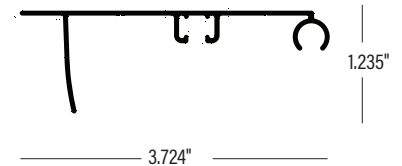

## 3" x 5" Atlas Beam

Size	White	Bronze	Driftwood	Wheat
24'	1365s324	1365s224	1365s424	1365s724

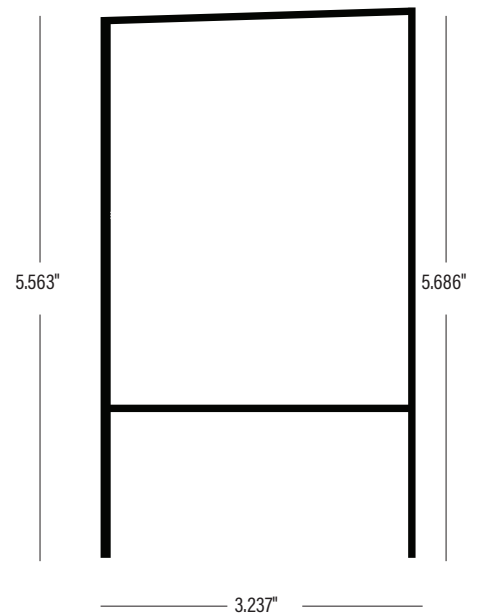

### Fluted Gutter Side Fascia

Size	White	Bronze	Clay	Wheat
24'	1321324	1321224	1321424	1321724



### 3" Extruded Header with Lip

Size	White	Bronze
24'	1330324L	
30'	1330330L	1330230L

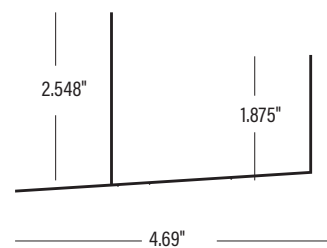

### 6" STR Valance

Size	White	Bronze	
13' 6"	1323010	1323009	
17'	1323004		
25'	1323007	1323006	1323005
27'	1323014	1323013	1323008
30'	1323009330		

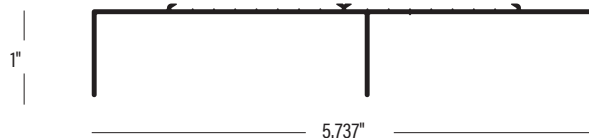

### Drip Edge Fascia

Size	Bronze	White
3" x 25'	2856225	2856325
4" x 25'	2858225	2858325

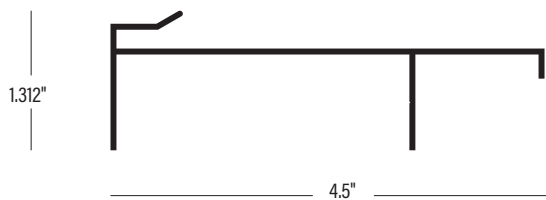

# Pool & Patio

## E Gutter

Size	White	Bronze
24'	1326324	1326224
30'	1326330	1326230

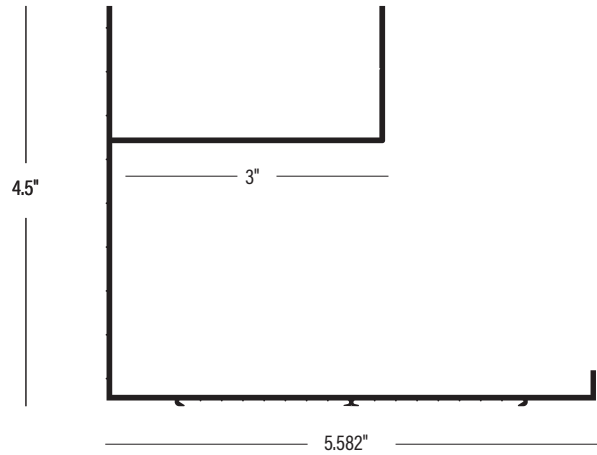

## 5" Super Gutter

Size	White	Bronze	Clay	Ivory
24'	1322324	1322224		1322624
30'	1322330	1322230	1322430	1322630
36'	1322336	1322236		
40'	1322340	1322240		

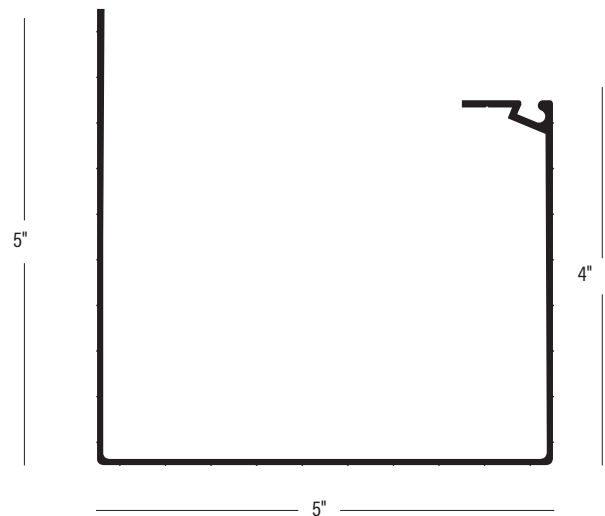

## Fluted Gutter

Size	White	Bronze	Clay	Ivory
24'	1319324	1319224	1319424	1319724

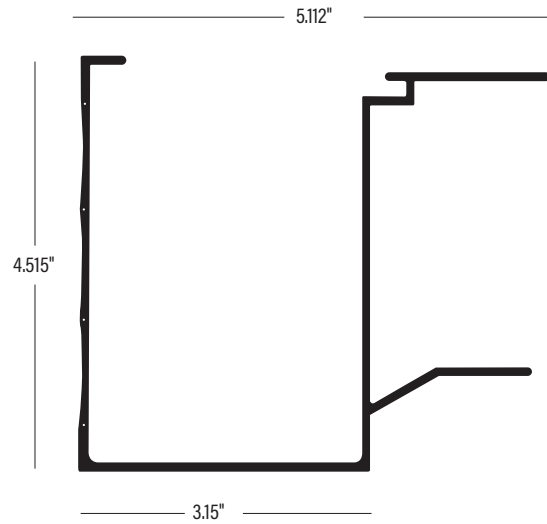

## 7" Super Gutter

Size	White	Bronze	Ivory
24'	1324324	1324224	
30'	1324330	1324230	1324630
36'	1324336	1324236	
40'	1324340	1324240	

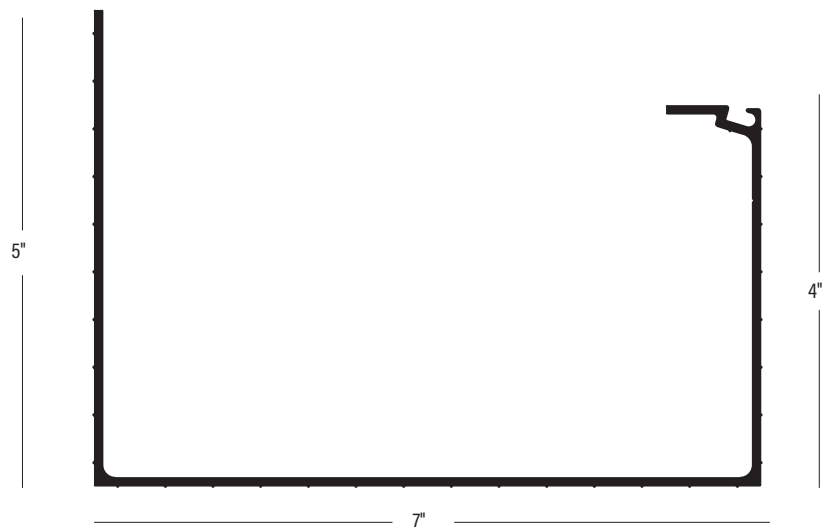

# Pool & Patio

## 7" Super Gutter (Regular .100)

Size	White	Bronze	Clay
24'	1323324	1323224	
30'	1323330	1323230	1323430
36'		1323236	
40'	1323340	1323240	

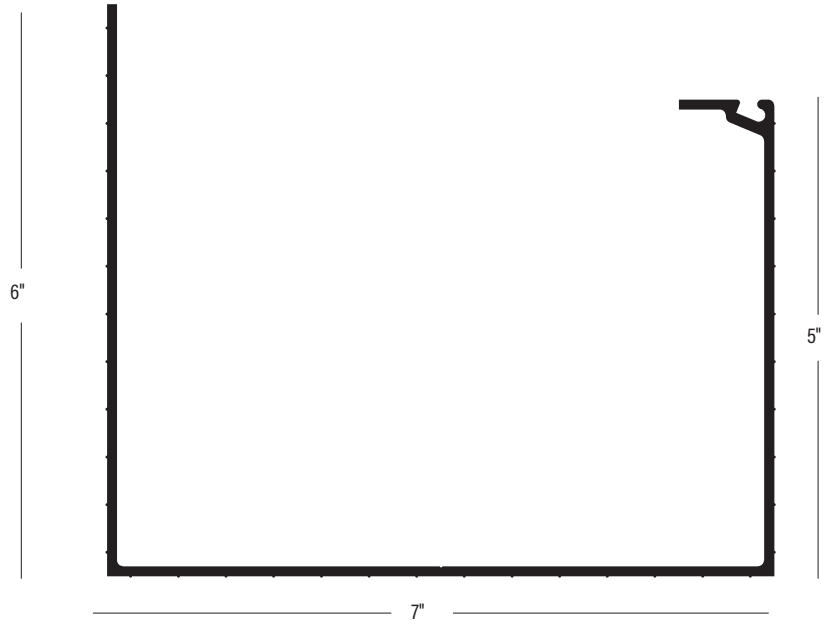

## 5" Super Gutter Bracket

Size	Mill Finish (Only)
16' 6"	1338016

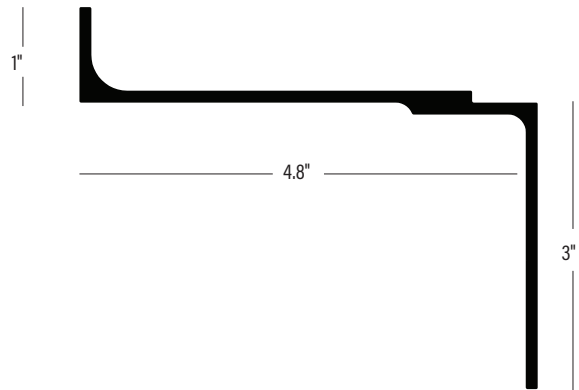

## 7" Super Gutter Bracket

Size	Mill Finish (Only)
16' 6"	1338116



## W Pan

Description	White	Bronze	Mill
24 ga Galvanized	GWP4080	GWP40M5	GWP40ML
040 Aluminum	AWP4080	AWP40M5	AWP40ML

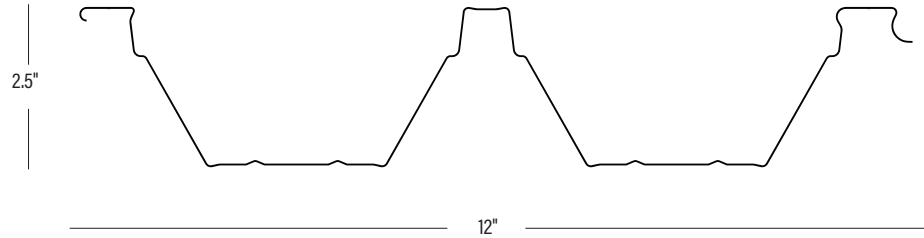

## W Pan Gutter

Description	White	Bronze	Mill
24 ga Galvanized - 25'	GSG402580	GSG4025M5	GSG4025ML
040 Aluminum - 25'	ASG402580	ASG4025M5	ASG4025ML

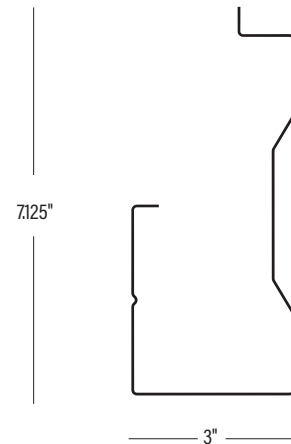

# Pool & Patio

## HR Railing Section

### 3/4" Picket HR-13

Size	White	Bronze	Black
19' 1"	1200318	1200218	1200920
19' 10"	1200319	1200219	1200919

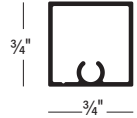

### 1" Picket HR-5

Size	White	Bronze	Black	Clay	Wheat
19' 10"	1204319	1204219	1204919	1204519	1204819
23"	1204323	1204223			
39"	1204339	1204239			

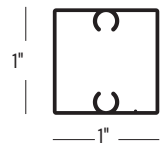

### Top Cap HR-1 (Mates w/HR-2)

Size	White	Bronze
20'	1206320	1206220

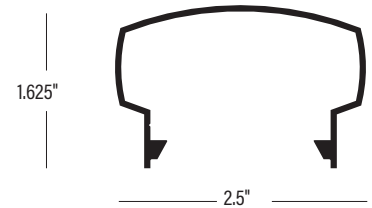

### Top Cap HR-10

Size	White	Bronze
20'	1210320	1210220

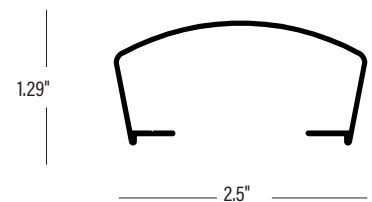

### Top Cap HR-14

Size	White	Bronze
20'	1212320	1212220

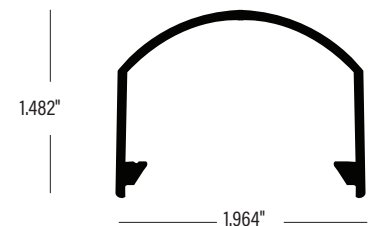

### Snap Plate HR-2 ((Mates w/HR-1, HR-3, HR-4, HR-4A, HR-4C, HR-14)

Size	White	Bronze	Black
19' 6"	1232319	1232219	
20'	1232320	1232220	
23'	1232323	1232223	1232923



### Snap Plate HR-2A

Size	White	Bronze
20'	1234320	1234220



### Snap Post HR-4 ((Mates w/HR-2))

Size	White	Bronze
19' 6"	1222319	1222219
20'	1222320	1222220
23'	1222323	1222223

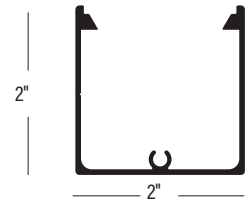

### Snap Post HR-4A (Mates w/HR-2)

Size	White	Bronze
20'	1224320	1224320
23'	1224323	1224223

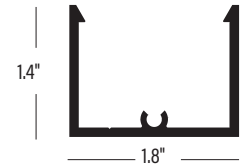

### Snap Channel HR-16

Size	White	Bronze
23'	1228323	1228223

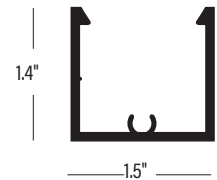

### Snap Plate HR-15

Size	White	Bronze
23'	1230323	1230223



### Bottom Channel HR-3

Size	White	Bronze
19' 6"	1216319	1216219
20'	1216320	1216220
23'	1216323	1216223



### Bottom Channel HR-12B

Size	White	Bronze
20'	1220320	1220220



# Pool & Patio

## Castings

### HR-1 End Cap

White	Bronze	Mill Finish
2262003	2262002	2262100



### HR-1 Wall Bracket

White	Bronze	Mill Finish
2272003	2272002	2272100



### HR-4 Base Plate

White	Bronze	Mill Finish
2260003	2260002	2260100



### HR-4A Base Plate

White	Bronze
2261003	2261002



### HR-3 Wall Bracket

White	Bronze	Mill Finish
2274003	2274002	2274100



### Base Plate (No Ears) 3"

Bronze	Mill Finish
2252002	2252100



### 3" Internal Post Inserts

White	Bronze	Mill Finish
2252003	2252002	2252100

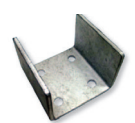

### 3" Internal Post Inserts w/Ears

White	Bronze	Mill Finish
2250003	2250002	2250100



### 4" Internal Post Inserts

LP13950
---------



### 4" Internal Post Inserts w/Ears

LP14040



### 4" Internal Post Inserts 3 Spline

LP13951



### Pyramid Square End Caps 2"

White	Bronze
2264203	2264202

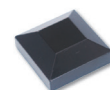

### Pyramid Square End Caps 3" (Special Order Only)

White	Bronze	Mill Finish
2264303	2264302	2264301

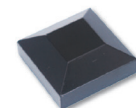

### Pyramid Square End Caps 4"

White	Bronze	Mill Finish
2264403	2264402	2264401

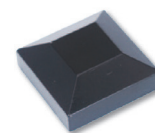

### S.S. Gravity Gate Latch

White	Bronze	Mill Finish	Black
2286300	2286202	2286000	2286200



### Heavy Duty Gate Hinge

White	Bronze	Black
2288000	2287000	2289000



# Pool & Patio

## Phifer Screen & Spline

### 18/14 Screen 100ft Per Roll

Width (inches)	Charcoal	Gray
36	1420036	1422036
42	1420042	
48	1420048	1422048
60	1420060	1422060
66	1420066	
72	1420072	1422072
78	1420078	1422078
84	1420084	1422084
90	1420090	1422090
96	1420096	1422096
102	1420102	
108	1420108	1422108
132	1420132	

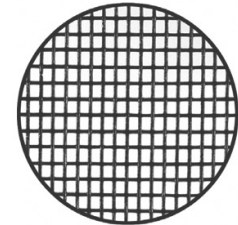

### 18/16 Screen 100ft Per Roll

Width (inches)	Charcoal	Gray
28	1426028	1428028
36	1426036	1428036
48	1426048	1428048
72	1426072	1428072
84	1426084	1428084

Note: Rom Rolls Are Generally 600 Sq ft In Length

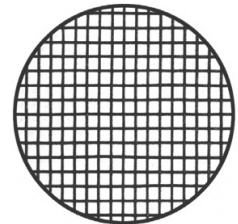

### 18/16 ROM Screen (Special Order)

Width (inches)	Charcoal	Gray	SQ FT Total
36	1430036	1432036	1800 SQ FT
48	1430048	1432048	2400 SQ FT
60	1430060	1432060	3000 SQ FT

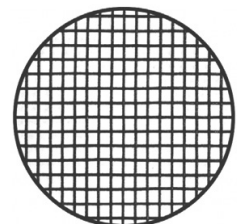

### 20/20 Screen 100ft Per Roll

Width (inches)	Charcoal	Gray
36	1434036	1436036
48	1434048	1436048
60	1434060	1436060
72	1434072	1436072
84	1434084	1436084
96	1434096	

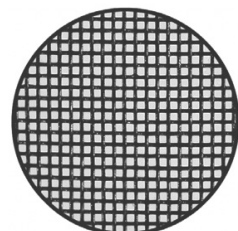

### 20x30 Screen 100ft Per Roll

Width (inches)	Charcoal
36	1438036
48	1438048
60	1438060
72	1438072
84	1438084

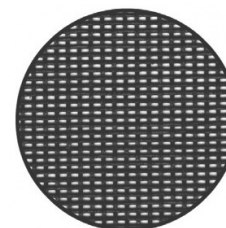

### SunScreen 100ft Per Roll

Width (inches)	Charcoal	Gray	Ant. Ivory	White	Bronze
36	1450036	1452036	1454036	1456036	1458036
48	1450048	1452048	1454048	1456048	1458048
60	1450060	1452060	1454060	1456060	1458060
72	1450072	1452072	1454072	1456072	1458072
84	1450084	1452084	1454084	1456084	1458084
96	1450096	1452096	1454096	1456096	1458096

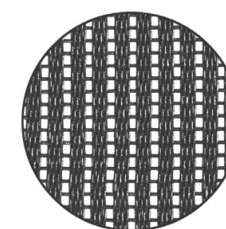

### SunTex 80 Screen 100ft Per Roll (Special Order)

Width (inches)	Black
36	1446036
48	1446048
60	1446060
72	1446072
96	1446096

*\*Also available in Brown, Grey, Stucco and Tan.*

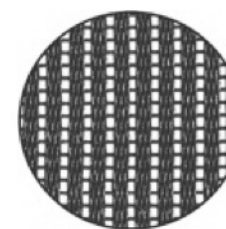

### SunTex 90 Screen 100ft Per Roll (Special Order)

Width (inches)	Black
36	1449036
48	1449048
60	1449060
72	1449072
96	1449096

*\*Also available in Brown, Grey, Stucco and Tan.*

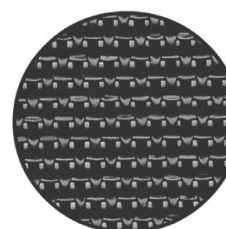

# Pool & Patio

## Tuff Screen

Width (inches)	Black
36	1473036
48	1473048
60	1473060
72	1473072
84	1473084
96	1473096
120	14730120
132	1473132

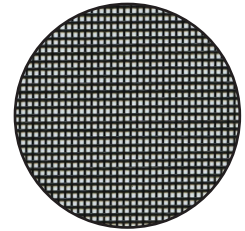

## Tuff Screen (No-See-Um)

Width (inches)	Black
36	1473336
48	1473348
60	1473360
72	1473372
84	1473384
96	1473396
120	14733120
132	1473132

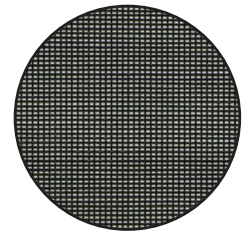

## Florida Glass Screen 100ft Per Roll (No Warranty)

Width (inches)	Charcoal
36	1442036
72	1442072

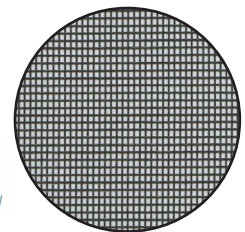

## Pet Screen 100ft Per Roll

Width (inches)	Black	Gray
30	1465030	1466030
36	1465036	1466036
48	1465048	1466048
60	1465060	1466060
72	1465072	

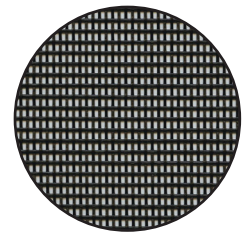

## Super Solar 100ft Per Roll

Width (inches)	Charcoal	Bronze
36	1441036	
48	1441048	1445036
60	1441060	1445048
84	1441084	1445084

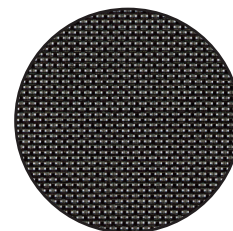

## Spline

Size/Type	Feet Per Roll	Black	Gray
120	2000	1620000	
125	2500	1625000	
140	2000	1628000	
145	2000	1627000	
150	1500	1632000	
160	1500	1636000	
170	1500	1640000	
175 Serrated	1500	1643000	
180	1000	1644000	
190	1000	1648000	
200	1000	1652000	
210 Square	1000	1630000	
210	1000	1656000	
220	1000	1660000	1662000
225 Square	1000	1630100	
225	800	1663000	
230 Serrated	1000	1665000	
230	1000	1664000	
235	1000	1668000	
240	750	1672000	
250	750	1676000	1676001
Std Flat	1000	1690000	1692000
Std Flat	1500	1690001	
290 Flat	250	1688000	
325 Flat	1000	1690002	
335 Flat	1000	1690003	
C-Spline	1500	1698000	
Kickplate Spline - Round	1000	1694000	
Kickplate Spline - Flat	1000	1694001	
Kickplate Spline Per Foot	1	1695000	
White Flat Spline	1000	1690004	

*Check with your local branch for availability*

# Pool & Patio

## Window Screen Frame

### Frame, Corners, and Clips

Size/Type	White	Bronze	Mill Finish	Flange
19-006 7/16" x 1 1/16" Frame*	1500312	1500212	1500012	5/16" x 1/4"
19-006 Corners (60-006)*			1550000	5/16" x 1/4"
19-006 Stretcher Clips (83-046)*			1594000	5/16" x 1/4"
19-011 5/16" x 3/4" Frame	1504312	1504212	1504012	Box
19-011 Corners (60-011)			1556000	Box
19-011 Stretcher Clips (83-006)			1596000	Box
19-012 5/16" x 19/32" Frame	1506312	1506212	1506012	Box
19-012 Corners (60-012)			1558000	Box
19-012 Stretcher Clips (83-012)			1598000	Box
19-015 7/16" x 1 1/16" Frame	1508312	1508212	1508012	Box
19-015 Corners (60-015)			1560000	Box
19-015 Stretcher Clips (83-013)			1600000	Box
19-016 5/16" x 1 3/16" Frame*	1510312	1510212	1510012	5/16" x 13/16"
19-016 Corners (60-016)*			1562000	5/16" x 13/16"
19-016 Stretcher Clips (83-016)*			1612000	5/16" x 13/16"
19-021 1/4" x 3/4" Frame*	1512312	1512212	1512012	Box
19-021 Corners (60-021)*			1566000	Box
19-021 Stretcher Clips*			None	Box
19-051 5/16" x 3/4" Frame*	1514312	1514212	1514012	Box
19-051 Corners (60-051)*			1568000	Box
19-051 Stretcher Clips (83-051)*			None	Box
19-056 3/8" x 3/4" Frame*	1516312	1516212	1516012	1/4"
19-055 Corners (60-055)*			1570000	1/4"
19-055 Stretcher Clips (83-055)*			1602000	1/4"
19-088 3/8" x 3/4" Frame*	1520312	1520212	1520012	Box
19-088 Corners (60-088)*			1574000	Box
19-088 Stretcher Clips*			None	Box
19-091 5/16" x 1 1/16" Frame*	1522312	1522212	1522012	3/16" x 1/4"
19-091 Corners (60-091)*			1576000	3/16" x 1/4"
19-091 Stretcher Clips (83-091)*			1606000	3/16" x 1/4"
20-010 7/16" x 3/4" Frame*	1524312	1524212	1524012	Box
20-010 Corners (60-010)*			1554000	Box
20-010 Stretcher Clips (83-010)*			1610000	Box
36-004 1/4" x 3/4" Cross Brace	1528312	1528212	1528012	Box
36-004 1/4" x 3/4" Cross Brace Insert			1578000	Box
Corner Tension Spring			1581000	Box
7/16" Extruded Screen Frame 16ft	1530316	1530216	1530016	Box
Top Deep H Bar 16ft	1532316	1532216	1532016	Box
Bottom Shallow H Bar 16ft	1534316	1534216	1534016	Box
Aluminum Tension Spring			1580000	
Aluminum Screen Lifts	1586000	1584000	1582000	Box
Vinyl Screen Lifts	1592000	1590000		Box
Wire Loop Screen Pulls			1549000	

\* Special Order Only

## Screen Tools

### Frame, Corners, and Clips

Description	Part #
Deluxe Spline Roller	LP15600
Cutting Edge Spline Roller	1749000
220/Flat Spline Aluminum Handle Roller	2522000
220/Flat Spline Wood Handle Roller	2524000
Sealed Bearings	2532000
140 Roller Wheel Without Bearing	2536000
140 Roller Wheel With Bearing	2538000
165/180 Roller Wheel Without Bearing	2540000
Flat Spline Roller With Bearing	2554000
Utility Knife with Spline Roller	2699005
Dehner Spline Roller With Blade	2703089

## Ultra Barrier

### Ultra Barrier

Description	Part #
1 x 2 BLACK 125'	1695002
1 x 3 BLACK 125'	1696002



# Pool & Patio

## Screen Doors

### Screen Door Frames - 35 5/8" x 79 1/2" w/ 3" Pushbar

Description	White	Bronze
3/0 6/8 Lined Screen Door Frame 8" KP	1800308	1800208
3/0 6/8 Lined Screen Door Frame 16" KP	1800316	1800216
3/0 6/8 Lined Screen Door Frame 24" KP	1800324	1800224
3/0 6/8 Lined Screen Door Frame 36" KP	1800336	1800236
3/0 6/8 Lined Screen Door Frame 14" KP		18002W9
Lined Screen Door Frame 48" - 16KP	180031648	180021648
Lined Screen Door Frame 48" - 8KP	1800348	1800248
Lined Screen Door Frame 16 wdggrain KP	1802w16	

Prehung Doors: Hinged Left or Right (from Outside looking in)  
 Jamb: Full Z or Half-Z Kickplate Sizes: 8", 16", 24" & 36"  
 Standard Door has a Day Light Opening Size: 36" x 80"



### Pre-Hung Screen Doors 36" x 80" DLO

Description	White	Bronze
PHR Frame Full Z-8KP	1826308	1826208
PHR Frame Full Z-16KP	1826316	1826216
PHR Frame Full Z-16KP Woodgrain	18263W6	18262W6
PHR Frame Full Z-16KP Wthstrp	1827316	1827216
PHR Frame Full Z-24KP	1826324	1826224
PHL Frame Full Z-8KP	1828308	1828208
PHL Frame Full Z-16KP	1828316	1828216
PHL Frame Full Z-16KP Woodgrain	18283W6	1828W6
PHL Frame Full Z-16KP Wthstrp	1829316	1829216
PHL Frame Full Z-24KP	1828324	1828224



### Shed Door Frames - 35 5/8" x 79 1/2" (Special Order Only)

Description	White	Bronze
Bronze Frame with White Coil		1860200
Bronze Frame with Ivory Coil		1863200
Bronze Frame with Bronze Coil		1861200
White Frame with Ivory Coil		1863300
White frame with White Coil		1860300
Prehung Shed Door Full Z White/White 36 x 80		1863000

Prehung Doors: Hinged Left or Right (from Outside looking in)  
 Jamb: Full Z or Half-Z Kickplate Sizes: 8", 16", 24" & 36"  
 Standard Door has a Day Light Opening Size: 36" x 80"



# Doorjamb & Frame Extrusions

## Full Z w/Felt Groove

Size	White	Bronze
17'	1156317	1156217

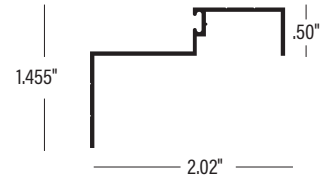

## 1/2" Z Jamb (Also Used As Astragal For Dbl. Door)

Size	White	Bronze
17'	1162317	1162217

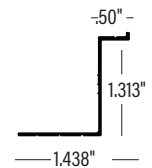

## Adjustable Z Jamb w/Felt Groove

Size	White	Bronze
17'	1159317	1159217

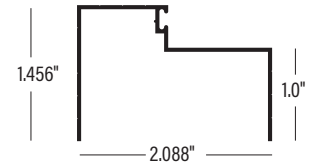

## 2" x 3" Door Jamb

Bronze 20'	Bronze 24'	White 20'	White 24'
1148220	1148224	1148320	1148324

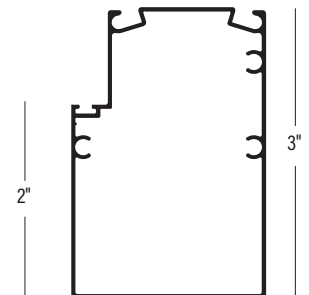

## 2" x 2" Jamb w/Felt Groove

Size	White	Bronze
19'	1152319	1152219
20'	1152320	1152220
24'	1152324	1152224

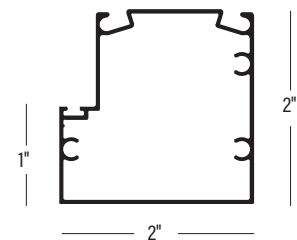

# Pool & Patio

## Door Expander

Size	White	Bronze
3'	1168303	1168203
4'	1168348	1168248
12'	1168312	1168212

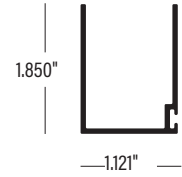

## Screen Door Main Frame

Size	White	Bronze
19.5'	1170319	1170219

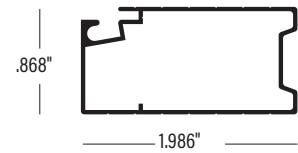

## 3" Push Bar

Size	White	Bronze
16'	1176316	1176216

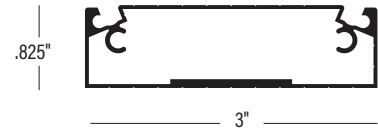

## Kick Plate Bar

Size	White	Bronze
13' 4"	1180313	1180213

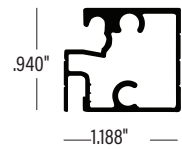

# Door Accessories

## Full Z w/Felt Groove

Description	White	Bronze
Latch & Closer Kit w/SS Rod	2049300	2049200
MillFast Hardware Kit	2050900	2050901
Quill One Stop C-Kit	2050999	2050998
Premium Door Kit*	2051300	2051200
Deluxe Latch & Closer Kit*	2050300	2050200
Eliminator Latch & Closer Kit*	2050403	2050402
Wright Closure Kit*	2055300	2055200

*\*Available in Pensacola, FL Only*



## Cylinder Closer Only

White	Bronze
2052300	2052200



## Standard Keylock

White	Bronze
2056300	2056200



## Inswing Latch

White	Bronze
2058300	2058200



## Screen & Shed Door Hinge

White	Bronze
2064300	2064200



# Pool & Patio

## Striker - High Profile

White	Bronze
2084300	2084200



## Bugsweep - 36"

White	Bronze
2066300	2066200



## Bugsweep - 48"

White	Bronze
2068300	2068200



## Plastic Jamb Bracket For Closer

White	Bronze
2076300	2076200



## Metal Jamb Bracket For Close

White	Bronze
2074300	2074200



## 1/2" Screen Door Threshold 36" - MF

Bronze
2094000



## 1" HVOS Threshold 36"

Bronze
2090000



# Door Grills

## Mesh Grill

White	Bronze
2098300	2098200

Sliding door arrangements, locks, handles and accessories are determined as viewed from the outside looking in. Special sizes available. Also available built & screened!



# Pet Doors

## Magnalock

Description	White	Bronze
Small Magnalock Pet Door (Pet under 20 lbs) with 4 3/4" x 7" Flap	2030000	2030001
Medium Magnalock Pet Door (Pet 20 - 50 lbs) with 8 1/2" x 12 1/2" Flap	2032000	2032100
Large Magnalock Pet Door (Pet over 50 lbs) with 11 1/2" x 17" Flap	2034000	2033200



## Pride

Description	White	Bronze
Small Pride Pet Door (Pet under 20 lbs) with 4 3/4" x 7" Flap	2030300	2032200
Medium Pride Pet Door (Pet 20 - 50 lbs) with 8 1/2" x 12 1/2" Flap	2032300	2032200
Large Pride Pet Door (Pet over 50 lbs) with 11 1/2" x 17" Flap	2034300	2034200
Extra Large Pride Pet Door with 14 1/2" x 19 1/2" Flap	20343XL	20342XL



# Pool & Patio

## Zeus Ultimate Screen Doors

### Convenient all in one packaging! Everything Is Included

- Aluminum Screen Door
- Z-Bar
- Piano Hinge
- Bug Sweep
- EZ Pull Handle
- Closure Tube

### Superior Packaging & Product Visibility

- All sides corrugated wrapped
- Heat shrink sealed
- All hardware in package
- Easily identify door design
- Convenient color selection

### 5 Colors Available

White, Bronze, Clay, Wheat, Black and Driftwood



## Samson Patio Screen Doors

### Features

- Heavy Dual Wall Aluminum Frame
- Strong Aluminum Corner Key
- Exclusive Self-Locking Screen System™
- Integrated Screen Trim Channel
- Flexible Vinyl or Rigid Vinyl with Wool Pile Seals
- Premium Recessed Handle
- Oversized 1¼" Rollers

### Order To Size

- Available up to 72" wide by 120" high

### Standard Powder Coated Finishes

- White and Bronze

### Optional Accessories

- Optional Stainless Steel Coastal Package
- Optional Nylon Roller Wheels
- Astragal for French Door Configuration

### Optional Powder Coated Finishes

- Ivory, Sandstone, Clay, and Black



## Quick Ship Door Designs



NL-2000  
(Palm Tree)  
Sea Brook  
Left  
35<sup>5</sup>/<sub>8</sub>" x 79<sup>1</sup>/<sub>2</sub>"



NR-2000  
(Palm Tree)  
Sea Brook  
Right  
35<sup>5</sup>/<sub>8</sub>" x 79<sup>1</sup>/<sub>2</sub>"



NL-2010  
(Heron)  
Galveston  
Left  
35<sup>5</sup>/<sub>8</sub>" x 79<sup>1</sup>/<sub>2</sub>"



NR-2010  
(Heron)  
Galveston  
Right  
35<sup>5</sup>/<sub>8</sub>" x 79<sup>1</sup>/<sub>2</sub>"



P-100  
Imperial  
35<sup>5</sup>/<sub>8</sub>" x 79<sup>1</sup>/<sub>2</sub>"



P-110-200L  
(Palm)  
Coconut Grove  
Left  
35<sup>5</sup>/<sub>8</sub>" x 79<sup>1</sup>/<sub>2</sub>"



P-110-200R  
(Palm)  
Coconut Grove  
Right  
35<sup>5</sup>/<sub>8</sub>" x 79<sup>1</sup>/<sub>2</sub>"



P-110-201L  
(Heron)  
Glades  
Left  
35<sup>5</sup>/<sub>8</sub>" x 79<sup>1</sup>/<sub>2</sub>"



P-110-201R  
(Heron)  
Glades  
Right  
35<sup>5</sup>/<sub>8</sub>" x 79<sup>1</sup>/<sub>2</sub>"



P-110  
Majestic  
35<sup>5</sup>/<sub>8</sub>" x 79<sup>1</sup>/<sub>2</sub>"



P-110-204L  
(Golfer)  
Heritage Links  
Left  
35<sup>5</sup>/<sub>8</sub>" x 79<sup>1</sup>/<sub>2</sub>"



P-110-204R  
(Golfer)  
Heritage Links  
Right  
35<sup>5</sup>/<sub>8</sub>" x 79<sup>1</sup>/<sub>2</sub>"



P-110-206  
(Pineapple)  
Pacifica  
35<sup>5</sup>/<sub>8</sub>" x 79<sup>1</sup>/<sub>2</sub>"



P-120  
Gershwin  
35<sup>5</sup>/<sub>8</sub>" x 79<sup>1</sup>/<sub>2</sub>"



O-270  
St. Charles  
35<sup>5</sup>/<sub>8</sub>" x 79<sup>1</sup>/<sub>2</sub>"



O-260  
Julia Street  
35<sup>5</sup>/<sub>8</sub>" x 79<sup>1</sup>/<sub>2</sub>"



O-250  
French Quarter  
35<sup>5</sup>/<sub>8</sub>" x 79<sup>1</sup>/<sub>2</sub>"



C-500  
Portofino  
35<sup>5</sup>/<sub>8</sub>" x 79<sup>1</sup>/<sub>2</sub>"

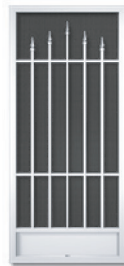

C-510  
Capri  
35<sup>5</sup>/<sub>8</sub>" x 79<sup>1</sup>/<sub>2</sub>"



Q-1515  
Riverside  
35<sup>5</sup>/<sub>8</sub>" x 79<sup>1</sup>/<sub>2</sub>"



I-750  
Palmer Woods  
35<sup>5</sup>/<sub>8</sub>" x 79<sup>1</sup>/<sub>2</sub>"



Q-1540  
Oak Park  
35<sup>5</sup>/<sub>8</sub>" x 79<sup>1</sup>/<sub>2</sub>"



A-500  
Westmore  
35<sup>5</sup>/<sub>8</sub>" x 79<sup>1</sup>/<sub>2</sub>"

# Pool & Patio

## Designer Door Series

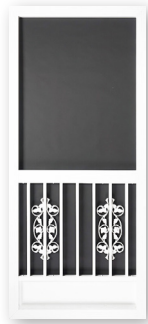

Rosette



Elegance



Contemporary

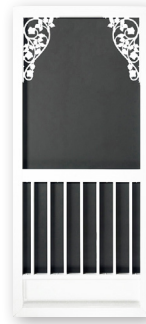

Sea View

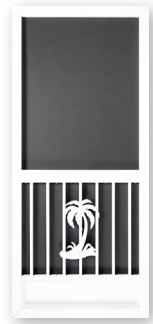

Palm Tree

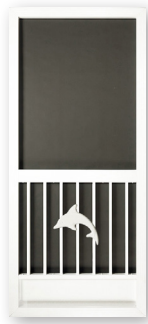

Dolphin



Seahorse



Sail Fish



Full Contemporary

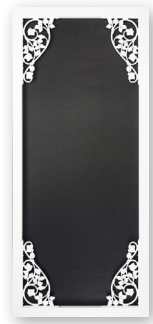

Full Seaview

### Specifications:

- 6063-T Hollow Aluminum Extrusions.
- .062" thick extrusions with areas at .090" on push-bar for closure installation and support.
- Finish Colors: White or Bronze
- Pre-hung Z-Bar: Deluxe Full-Z weather strip standard with 4 hinges.
- Custom designs are available

### EZ-Roller 3 in 1 Tool



### Installation Components

- Piano Hinge: 80" & 96"
- Piano Hinge with Side Expander: 80" & 96"
- Adjustable Bug Sweep: 38" & 48"

## Locks and Handles

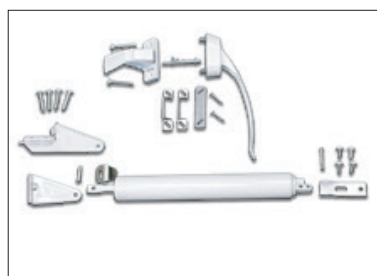

EZ-Pull Handle Kit

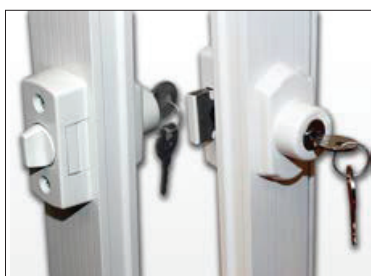

Kephart Deadlock



Albright In-Swing Handle



Tasman Locking Handle



Closure Tube (with corner bracket & SS jamb bracket)



In-Swing Bracket

## Sunburst Rings



- B-3, B-5, B-7
- C-3, C-5, C-7

## Astragals

- 80" & 96"

## Side-Lite Components

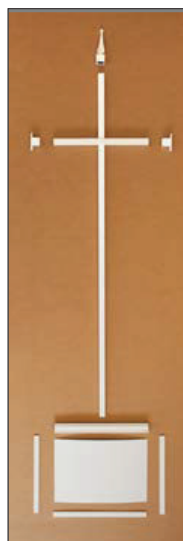

- Scrolls- Full, Half, & Corner
- Spear for 3/4" Pickets
- Shoes for 3/4" Pickets
- Punch pieces for side lites, single hole up to 30" wide
- 3/4" Picket: 48", 72", 96"

# Pool & Patio

## Designer Screen Doors & Accessories

### Half Scroll OS-H10

White	Bronze
2012300	2012200



### Corner Scroll OS-C10

White	Bronze
2014300	2014200



### Spear OS-S10

White	Bronze
2016300	2016200



### Sunburst Ring 22 1/4" x 11 1/8" SB-B3

White	Bronze
2018300	2018200



### Sunburst Ring 11 1/2" x 5 3/4" SB-C3

White	Bronze
2020300	2020200



### Astragal with FB

Size	White	Bronze
81 1/2"	2024300	2024200
96"	2024302	2024202



### Astragal without FB

Size	White	Bronze
81 1/2"	2024301	2024201

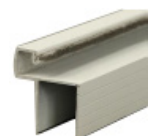

### Tasman Latch & Closer Kit

White	Bronze
2022300	2022200



### Screen Door Deadlock

White	Bronze
2001158	2001159



### Bugsweep

Size	White	Bronze
36"	2024306	2024305
48"	2025306	2025348



Most Items on pages 47-48 are available by Special Order Only. Please contact your nearest branch for availability

# Pool & Patio

## T&C-Ultracote 410 Stainless Steel Screws

### 410SS Sheet Metal Screws

Size	Color	Package	Bulk
8 X ½ SMS 410SS UC	Bronze	22142PCSS4 (1000 pieces)	22142BCSS4 (10000 pieces)
8 X ½ SMS 410SS UC	White	22143PCSS4 (1000 pieces)	22143BCSS4 (10000 pieces)
10 X 1 SMS 410SS UC	Bronze	21722PCSS4 (500 pieces)	21722BCSS4 (6000 pieces)
10 X 1 SMS 410SS UC	White	21723PCSS4 (500 pieces)	21723BCSS4 (6000 pieces)
10 X 1½ SMS 410SS UC	Bronze	21762PCSS4 (500 pieces)	21762BCSS4 (5000 pieces)
10 X 1½ SMS 410SS UC	White	21763PCSS4 (500 pieces)	21763BCSS4 (5000 pieces)
10 X 2 SMS 410SS UC	Bronze	21802PCSS4 (500 pieces)	21802BCSS4 (3000 pieces)
10 X 2 SMS 410SS UC	White	21803PCSS4 (500 pieces)	21803BCSS4 (3000 pieces)
10 X 3 SMS 410SS UC	Bronze	21842PCSS4 (250 pieces)	21842BCSS4 (1000 pieces)
10 X 3 SMS 410SS UC	White	21843PCSS4 (250 pieces)	21843BCSS4 (1000 pieces)
10 X 4 SMS 410SS UC	Bronze	21882PCSS4 (100 pieces)	21882BCSS4 (1000 pieces)
10 X 4 SMS 410SS UC	White	21883PCSS4 (100 pieces)	21883BCSS4 (1000 pieces)



### 410SS Self Drill Screws

Size	Color	Package	Bulk
8 X 9/16 SDS 410SS UC	Bronze	21282PCSS4 (500 pieces)	21282BCSS4 (10000 pieces)
8 X 9/16 SDS 410SS UC	White	21283PCSS4 (500 pieces)	21283BCSS4 (10000 pieces)
10 X ¾ (1/4 HD) SDS 410SS UC	Bronze	21332PCSS4 (250 pieces)	21332BCSS4 (6500 pieces)
10 X ¾ (1/4 HD) SDS 410SS UC	White	21333PCSS4 (250 pieces)	21333BCSS4 (6500 pieces)
10 X ¾ (5/16 HD) SDS 410SS UC	Bronze	21342PCSS4 (250 pieces)	21342BCSS4 (7500 pieces)
10 X ¾ (5/16 HD) SDS 410SS UC	White	21343PCSS4 (250 pieces)	21343BCSS4 (7500 pieces)
12 X ¾ SDS 410SS UC	Bronze	21352PCSS4 (250 pieces)	21352BCSS4 (5000 pieces)
12 X ¾ SDS 410SS UC	White	21353PCSS4 (250 pieces)	21353BCSS4 (5000 pieces)
14 X ¾ SDS 410SS UC	Bronze	21582PCSS4 (250 pieces)	21582BCSS4 (4000 pieces)
14 X ¾ SDS 410SS UC	White	21583PCSS4 (250 pieces)	21583BCSS4 (4000 pieces)
14 X 1 SDS 410SS UC	Bronze	21602PCSS4 (250 pieces)	21602BCSS4 (3000 pieces)
14 X 1 SDS 410SS UC	White	21603PCSS4 (250 pieces)	21603BCSS4 (3000 pieces)
14 X 2 SDS 410SS UC	Bronze	21542PCSS4 (250 pieces)	21542BCSS4 (1200 pieces)
14 X 2 SDS 410SS UC	White	21543PCSS4 (250 pieces)	21543BCSS4 (1200 pieces)



### 410SS Concrete Screws

Size	Color	Package	Bulk
¼" X 1 ¾" C.SCR 410SS UC	Bronze	25702PCSS4 (100 pieces)	25702BCSS4 (2000 pieces)
¼" X 1 ¾" C.SCR 410SS UC	White	25703PCSS4 (100 pieces)	25703BCSS4 (2000 pieces)
¼" X 2 ¼" C.SCR 410SS UC	Bronze	25722PCSS4 (100 pieces)	25722BCSS4 (1500 pieces)
¼" X 2 ¼" C.SCR 410SS UC	White	25723PCSS4 (100 pieces)	25723BCSS4 (1500 pieces)
¼" X 3" C.SCR 410SS UC	Bronze	25742PCSS4 (100 pieces)	25742BCSS4 (1000 pieces)
¼" X 3" C.SCR 410SS UC	White	25743PCSS4 (100 pieces)	25743BCSS4 (1000 pieces)
¾" X 4" C.SCR 410SS UC	Bronze	2571005SS4 (100 pieces)	
¾" X 4" C.SCR 410SS UC	White	2571004SS4 (100 pieces)	
¾" X 5" C.SCR 410SS UC	Bronze	2571007SS4 (100 pieces)	
¾" X 5" C.SCR 410SS UC	White	2571006SS4 (100 pieces)	
¾" X 7" C.SCR 410SS UC	Bronze	2571011SS4 (100 pieces)	
¾" X 7" C.SCR 410SS UC	White	2571010SS4 (100 pieces)	



# T&C-Ultracote Carbon Steel Screws

## Carbon Steel Sheet Metal Screw SMS

Size	Color	Package	Bulk
8 X ½ SMS UC	Bronze	TC22142PC (1000 pieces)	TC22142BC (10000 pieces)
8 X ½ SMS UC	White	TC22143PC (1000 pieces)	TC22143BC (10000 pieces)
8 X ¾ SMS UC	White	TC22193PC (500 pieces)	TC22193BC (10000 pieces)
10 X 1 SMS UC	Bronze	TC21722PC (500 pieces)	TC21722BC (6000 pieces)
10 X 1 SMS UC	White	TC21722PC (500 pieces)	TC21722BC (6000 pieces)
10 X 1½ SMS UC	Bronze	TC21762PC (500 pieces)	TC21762BC (5000 pieces)
10 X 1½ SMS UC	White	TC21763PC (500 pieces)	TC21763BC (5000 pieces)
10 X 2 SMS UC	Bronze	TC21802PC (500 pieces)	TC21802BC (3000 pieces)
10 X 2 SMS UC	Bronze	TC21801BG (100 pieces)	TC21801BC (3000 pieces)
10 X 2 SMS UC	White	TC21803PC (500 pieces)	TC21803BC (3000 pieces)
10 X 2 SMS UC	White	TC21800BG (100 pieces)	TC21800BC (3000 pieces)
10 X 3 SMS UC	Bronze	TC21842PC (250 pieces)	TC21842BC (1000 pieces)
10 X 3 SMS UC	White	TC21843PC (250 pieces)	TC21843BC (1000 pieces)
10 X 4 SMS UC	Bronze	TC21882PC (100 pieces)	TC21882BC (1000 pieces)
10 X 4 SMS UC	White	TC21883PC (100 pieces)	TC21883BC (1000 pieces)
10 X 5 SMS US	White	21884PC (100 pieces)	21884BC (1000 pieces)

## Carbon Steel Self Drill Screw SDS

Size	Color	Package	Bulk
8 X ½ SDS UC	Bronze	TC21242PC (1000 pieces)	TC21242BC (10000 pieces)
8 X ½ SDS UC	White	TC21243PC (1000 pieces)	TC21243BC (10000 pieces)
8 X ⅙ SDS	Clay/Driftwood	LF02861 (500 pieces)	
8 X ⅙ SDS	Ivory	LF02870 (1000 pieces)	
8 X ⅙ SDS UC	Bronze	TC21282PC (500 pieces)	TC21282BC (10000 pieces)
8 X ⅙ SDS UC	White	TC21283PC (500 pieces)	TC21283BC (10000 pieces)
10 X ¾ (¼ HD) SDS UC	Bronze	TC21332PC (250 pieces)	TC21332BC (6500 pieces)
10 X ¾ (¼ HD) SDS UC	White	TC21333PC (250 pieces)	TC21333BC (6500 pieces)
10 X ¾ (⅙ HD) SDS	Bronze	TC21342PC (250 pieces)	TC21342BC (7500 pieces)
10 X ¾ (⅙ HD) SDS	White	TC21343PC (250 pieces)	TC21343BC (7500 pieces)
10 X 1 SDS UC	Bronze	TC21382PC (500 pieces)	TC21382BC (5000 pieces)
10 X 1 SDS UC	White	TC21383PC (500 pieces)	TC21383BC (5000 pieces)
10 X 1½ SDS UC	Bronze	TC21422PC (500 pieces)	TC21422BC (5000 pieces)
10 X 1½ SDS US	White	TC21423PC (500 pieces)	TC21423BC (5000 pieces)
10 X 2 SDS UC B	Bronze	TC21462PC (500 pieces)	TC21462BC (2000 pieces)
10 X 2 SDS UC	White	TC21463PC (500 pieces)	TC21463BC (2000 pieces)
12 X ¾ SDS UC	Bronze	TC21352PC (250 pieces)	TC21352BC (5000 pieces)
12 X ¾ SDS UC W	White	TC21353PC (250 pieces)	TC21353BC (5000 pieces)
12 X 1 SDS UC	White		2137730 (5000 pieces)
12 X 1 SDS UC	Bronze		2137720 (5000 pieces)
12 X 2 SDS UC	Bronze	TC21472PC (500 pieces)	TC21472BC (3000 pieces)
12 X 2 SDS UC	White	TC21473PC (500 pieces)	TC21473BC (3000 pieces)
14 X ¾ SDS UC	Bronze	TC21582PC (250 pieces)	TC21582BC (4000 pieces)
14 X ¾ SDS UC	White	TC21583PC (250 pieces)	TC21583BC (4000 pieces)
14 X 1 SDS UC	Bronze	TC21602PC (250 pieces)	TC21602BC (3000 pieces)
14 X 1 SDS UC	White	TC21603PC (250 pieces)	TC21603BC (3000 pieces)
14 X 2 SDS UC	Bronze	TC21542PC (250 pieces)	TC21542BC (1200 pieces)
14 X 2 SDS UC	White	TC21543PC (250 pieces)	TC21543BC (1200 pieces)
14 X 3 SDS UC	Bronze	TC21552PC (500 pieces)	TC21552BC (1000 pieces)
14 X 3 SDS UC	White	TC21553PC (500 pieces)	TC21553BC (1000 pieces)

# Pool & Patio

## Carbon Steel Concrete Screws

Size	Color	Package	Bulk
¼" X 1 ½" C.SCR UC	Bronze	TC25682PC (100 pieces)	TC25682BC (2000 pieces)
¼" X 1 ½" C.SCR UC	White	TC25683PC (100 pieces)	TC25683BC (2000 pieces)
¼" X 1 ¾" C.SCR UC	Bronze	TC25702PC (100 pieces)	TC25702BC (2000 pieces)
¼" X 1 ¾" C.SCR UC	White	TC25703PC (100 pieces)	TC25703BC (2000 pieces)
¼" X 2 ¼" C.SCR UC	Bronze	TC25722PC (100 pieces)	TC25722BC (1500 pieces)
¼" X 2 ¼" C.SCR UC	White	TC25723PC (100 pieces)	TC25723BC (1500 pieces)
¼" X 3" C.SCR UC	Bronze	TC25742PC (100 pieces)	TC25742BC (1000 pieces)
¼" X 3" C.SCR UC	White	TC25743PC (100 pieces)	TC25743BC (1000 pieces)
¼" X 4" C.SCR UC	Bronze	TC25762PC (100 pieces)	TC25762BC (1000 pieces)
¼" X 4" C.SCR UC	White	TC25763PC (100 pieces)	TC25763BC (1000 pieces)
¼" X 5" C.SCR UC	Bronze	TC25752PC (100 pieces)	TC25752BC (500 pieces)
¼" X 5" C.SCR UC	White	TC25753PC (100 pieces)	TC25753BC (500 pieces)
¼" X 5" C.SCR UC	Bronze	TC25752PC (50 pieces)	
¼" X 5" C.SCR UC	White	TC25753PC (50 pieces)	
¼" X 6" C. SCR	Bronze	TC25772PC (50 pieces)	
¼" X 6" C. SCR	White	TC25773PC (50 pieces)	
⅜" X 3" C.SCR UC	Bronze	TC2571002 (100 pieces)	
⅜" X 3" C.SCR UC	White	TC2571003 (100 pieces)	
⅜" X 4" C.SCR UC	Bronze	TC2571004 (100 pieces)	
⅜" X 4" C.SCR UC	White	TC2571005 (100 pieces)	
⅜" X 5" C.SCR UC	Bronze	TC2571006 (100 pieces)	
⅜" X 5" C.SCR UC	White	TC2571007 (100 pieces)	
⅜" X 5" C.SCR UC	Bronze	LF03811 (50 pieces)	
⅜" X 5" C.SCR UC	White	LF03821 (50 pieces)	
⅜" X 7" C.SCR UC	Bronze	TC2571010 (100 pieces)	
⅜" X 7" C.SCR UC	White	TC2571011 (50 pieces)	

## EPDM Washer SMS & SDS Screws

Size	Package
8 X ¾ HWH SMS W/ ¾" EPDM WASHER	LF02000 (4000 pieces)
8 X ¾ HWH SMS W/ ¾" EPDM WASHER	LF02010 (1000 pieces)
8 X ¾ HWH SMS W/ ¾" EPDM WASHER	2131100 (500 pieces)
8 X ¾ HWH SMS W/ ¾" EPDM WASHER	LF02200 (100 pieces)
10 X ¾ HWH SMS W/ ¾" EPDM WASHER	SWHT005 (1000 pieces)
10 X ¾ HWH SMS W/ ¾" EPDM WASHER	2218500 (250 pieces)
10 X ¾ HWH SELF DRILL W/ ¾" EPDM WASHER	2218400 (1000 pieces)
10 X ¾ HWH SELF DRILL W/ ¾" EPDM WASHER	LF03016 (200 pieces)
10 X ¾ HWH SELF DRILL W/ ¾" EPDM WASHER	2218300 (250 pieces)
10 X ¾ HWH SELF DRILL W/ ¾" EPDM WASHER	22181PC (100 pieces)
14 X 4 7/8 HWH SELF DRILL W/1 ½" EPDM WASHER	2135700 (100 pieces)
14 X 4 7/8 HWH SELF DRILL W/1 ½" EPDM WASHER	2193350 (50 pieces)
14 X 4 7/8 HWH SELF DRILL W/1 ½" EPDM WASHER	21356PC (25 pieces)
14 X 5 7/8 HWH SELF DRILL W/1 ½" EPDM WASHER	2135800 (100 pieces)
14 X 5 7/8 HWH SELF DRILL W/1 ½" EPDM WASHER	21931PC (50 pieces)
14 X 5 7/8 HWH SELF DRILL W/1 ½" EPDM WASHER	21366PC (25 pieces)
14 X 7 7/8 HWH SELF DRILL W/1 ½" EPDM WASHER	2193200 (50 pieces)
14 X 7 7/8 HWH SELF DRILL W/1 ½" EPDM WASHER	2135900 (25 pieces)

## Anchors

### Anchors

Description	Color	Part #
PLASTIC ANCHORS - ¼" With Lips - 100 Pcs		LF00080
TAPCON ¼ x 1 ¾ - Bulk CF	White	2570300
TAPCON ¼ x 1 ¾ - Bulk CF	Bronze	2570200
¼ x 2 ¼ - ITW- Box w/Bit 100 Pcs TAPCON	Bronze	2573220
TAPCON ¼ x 2 ¼ ITW	White	2572300
TAPCON ¼ x 2 ¼ ITW	Bronze	2572200
TAPCON ¼ x 4 -100 Pcs	White	2571300
TAPCON ¼ x 4 - 100 Pcs	Bronze	2571200

## Rivets

### Rivets

Description	Color	Part #
½"(AB44A) Aluminum POP RIVETS - 1000 Pcs	MF	LF01710
½"(AB44A) Aluminum POP RIVETS - 1000 Pcs	Bronze	LF01730
½"(AB44A) Aluminum POP RIVETS - 1000 Pcs	White	LF01750

## Lag Screws

### Lag Screws

Description	Color	Part #
¼" x 2" LAG SCREW	ZINC PLATED	2456000
¼" x 2 ¼" LAG SCREW - 100 Pcs	ZINC PLATED	
¼" x 2 ½" LAG SCREW	ZINC PLATED	2458000
¼" x 3" LAG SCREW	ZINC PLATED	2460000
¼" x 3 ½" LAG SCREW	ZINC PLATED	2462000
¼" x 4" LAG SCREW	ZINC PLATED	2464000
¼" x 6" LAG SCREW	ZINC PLATED	2466000
¼" x 8" LAG SCREW	ZINC PLATED	2468000
¾" x 10" LAG SCREW	ZINC PLATED	2468100

## Extensions

### Extensions

Description	Part #
¼" x 2" Extension	2360000
¼" x 4" Extension	2362000
¼" x 6" Extension	2364000

# Pool & Patio

## Drill Bits

### Drill Bits

Description	Part #
3/16" Jobber Drill Bit	2316000
3/16" Short Masonry Drill Bit	2328000
3/16" Long Masonry Drill Bit	2330000
1/4" Short Masonry Drill Bit	2332000
1/4" Long Masonry Drill Bit	2334000

## Cables

### Std SS Cable Set with Eyebolt and Tiebar

12ft	14ft	16ft
2686000	2687000	2687003

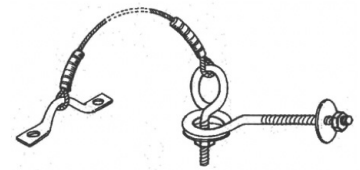

### Std SS Cable Set with Angle Bracket & Strap Plate

Length	White	Bronze
10 ft	2693310	2693210
12ft	2693312	2693212
14ft	2693314	2693214
16ft	2693316	2693216
18ft	2693318	2693218
20ft	2693320	2693220

\*Special Sizes Available

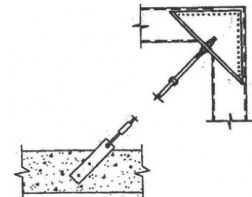

## Tape

### Sealant Tape

Description	White	Silver
2" Foil Tape - 24 Rolls Per Case 50ft /Roll	N/A	2650000
3" Peel & Seal Tar Tape 9 Rolls/Case 33ft/Roll 45mil	2638000	
4" Power Bond Tape 50ft 25mil	2639050	
6" Power Bond Tape 9 Rolls Per Case 50ft/Roll	2639051	
12" Peel & Seal Tape 9 Rolls Per Case 33ft/Roll	2641001	
18" Peel & Seal Tape 9 Rolls Per Case 33ft/Roll	2640018	
36" Peel & Seal Tape 9 Rolls Per Case 33ft/Roll	2640004	

## Caulking

### OSI Trim Caulking

Description	White	Bronze	Gray
SBR100-12 Tubes Per Case	2610300	2610200	2610100

### OSI Silicone Caulking

Description	White	Bronze	Clear
HM-270-12 Tubes Per Case	2618300	2618200	2618100

### OSI Window Sealant Caulking

Description	White	Bronze	Clear
Quad-12 Tubes Per Case	2630300	2630200	2630100

### Vulkem Caulking

Description	White	Bronze	Clear
30 Tubes Per Case	2616300	2616200	N/A

### Geocel Caulking

Description	White	Bronze	Clear
Geocel Caulking	White	Bronze	Clear
2300 Caulk Tube	2625300	2625200	2625100
2315 Caulk - 1 Gal	2626003	N/A	2625008
2315 Repair Kit	N/A	N/A	2626315

### Degaseal Pro 2000 Caulking

Description	White	Bronze	Clear
	2621300	2619200	2619100

### NovaGuard Silicone

Description	White	Bronze	Clear
	2617300	2617200	2617100

### GS121 Caulking

Description	White	Bronze	Clear
	2622300	N/A	N/A

### 20-20 Lap Seal

Description	White
4 @ 1 Gal Per Case	2642000

# Pool & Patio

## Solar Seal #900

Description	White	Bronze	Clear
12 Tubes Per Case	2631300	2631200	2631100

## 2320 Gutter Seal

Description	White	Bronze	Clear
12 Tubes Per Case - 10.6oz. EA	2627300	N/A	2627100

## 20-20 Seam Seal

Description	White	Bronze	Clear
4 Gal Per Case	N/A	N/A	2642000

## Miscellaneous

### Aluma Wax (Spray)

Description	Part #
12 Cans Per Case	2636000

### Duragel (Spray) Adhesive & Caulking Remover

Description	White	Bronze	Clear
12 Cans Per Case	2608000	N/A	N/A

### Spray Paint

Color	Part #
MB 40 Bronze	R0337670
Colonial White	2653000
Extrusion White	R0337669
Appliance White	2658000
Beige	2659000
Clay	R0313814

## Drivers

### Drivers

Description	Part #
¼" x 2" Hex Driver	2344000
¼" x 4" Hex Driver	2344001
⅝" x 2" Hex Driver	2346000
⅝" x 4" Hex Driver	2344002
⅜" x 2" Hex Driver	2348000
⅜" x 4" Hex Driver	2344003
⅞" x 2" Hex Driver	2350000
4" Panel Mate Pro Driver	2592002

# T&C-Ultradrive



## Impact rated drivers Made in the USA

1. Lobular design engages sides of screws, not the corners, reducing rounding and minimizing coating damage
2. 100% Made in the U.S.A.!
3. Made from "hardened" steel and guaranteed to last\*
4. Special "Torsion" 6" #2 & #3 Philips drive for installing and removing windows.  
Torsion drives are designed to "Flex" to reduce wear on old or new installation screw heads.
5. Each driver is color coated to simplify selection when on the job.
6. Impact tool rated HOWEVER we do not recommend impact drills on any coated screw.

\*Drivers are guaranteed not to fail under normal use. Colored coating is not covered.







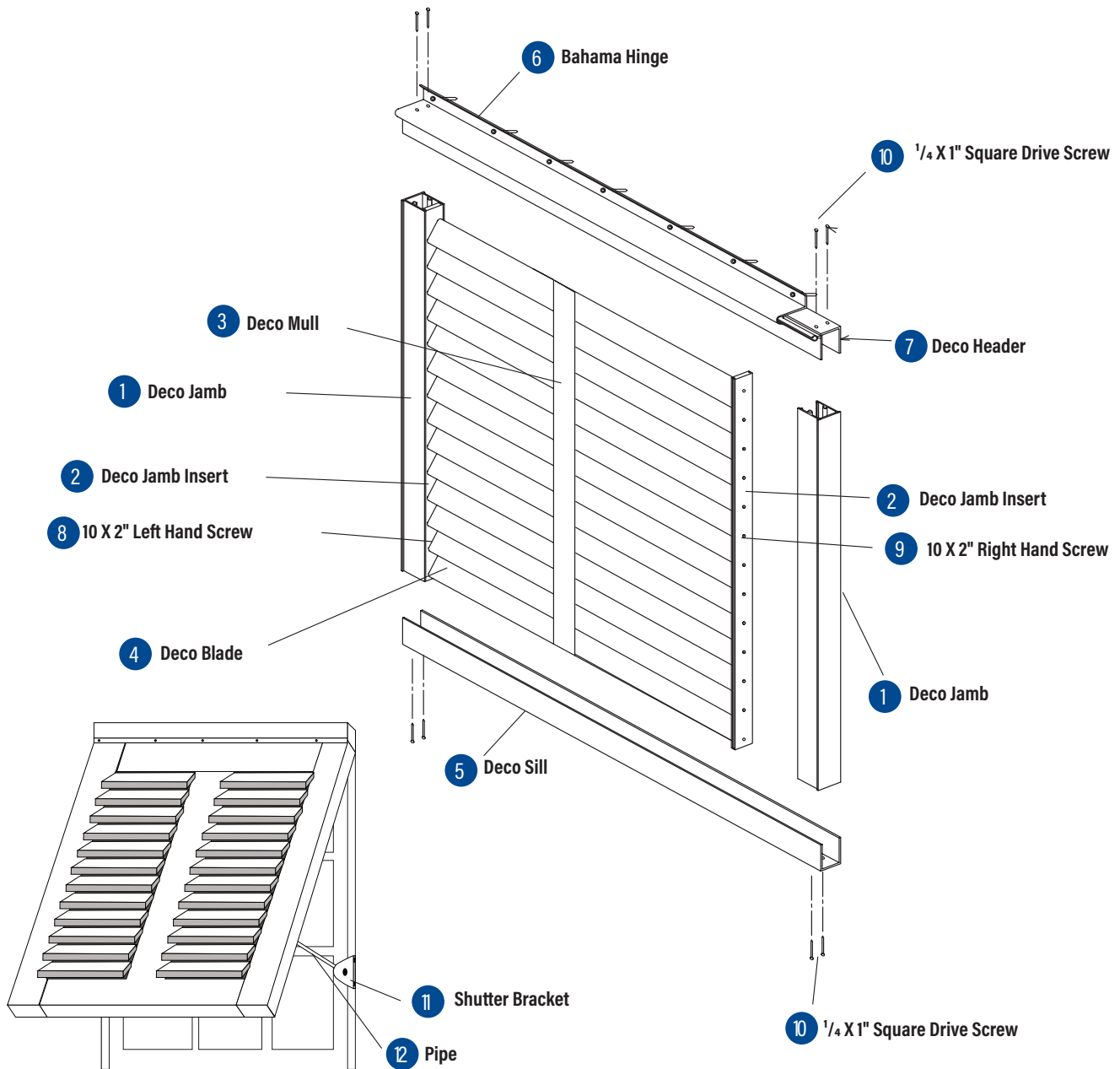

Description	Part #
1/4 X 2 3/16" T&C-ULTRADRIVE RED	KLMSHL14R
1/4 X 4" T&C-ULTRADRIVE RED	KLMSH144R
1/4 X 6" T&C-ULTRADRIVE RED	KLMSH146R
5/16 X 2 3/16" T&C-ULTRADRIVE GOLD	KLMSHL516G
5/16 X 4" T&C-ULTRADRIVE GOLD	KLMSH5164G
5/16 X 6" T&C-ULTRADRIVE GOLD	KLMSH5166G
3/8 X 2 3/16" T&C-ULTRADRIVE BLUE	KLMSHL38B
3/8 X 4" T&C-ULTRADRIVE BLUE	KLMSH384B
3/8 X 6" T&C-ULTRADRIVE BLUE	KLMSH386B
7/16 X 2 3/16" T&C-ULTRADRIVE GOLD	KLMSHL716G
#2 PHIL TORSION T&C-ULTRADRIVE NICKEL	T362PN
#3 PHIL TORSION T&C-ULTRADRIVE GOLD	T363PG
3/16" LOBE DRIVE (FOR 3/8" CONCRETE SCREWS)	LMSHL916
EA MALE BOLT DRIVER 3/16" GREEN	8422000
EA FEMALE BOLT DRIVER 1/4" HEX PURPLE	8423000

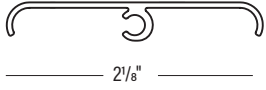
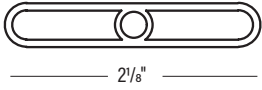
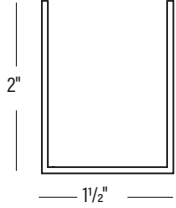
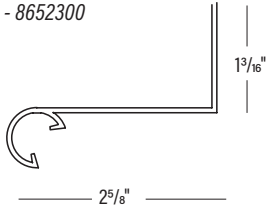
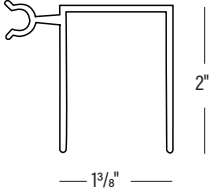
# Pool & Patio

## Deco Bahama Shutter

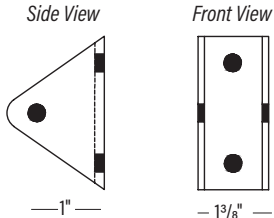
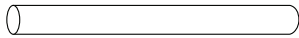

<p><b>Deco Jamb</b>            Length - 24 Foot            Mill Finish - DCB004124            White - DCB004324</p> <p>1 1/2"            1 7/8"</p>	<p><b>Deco Jamb Insert</b>            Length - 24 Foot            DCB005124</p> <p>1 3/16"            1/4"</p>	<p><b>Deco Mull</b>            Length - 24 Foot            Mill Finish - DCB000124            White - DCB000324</p> <p>1 3/8"            2"</p>
---	--	---

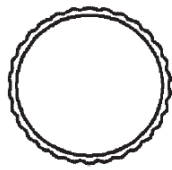
<p><b>Deco Solid Blade</b>                  Length - 24 Foot                  Mill Finish - DCB001124                  White - DCB001324</p> 	<p><b>Deco Hollow Blade</b>                  Mill Finish - DCB002124                  White - DCB002324</p> 	<p><b>Deco Sill</b>                  Length - 24 Foot                  Mill Finish - DCB003124                  White - DCB003324</p> 
<p><b>Bahama Hinge</b>                  Length - 21 Foot                  Mill Finish - 8652021                  White - 8652300</p> 	<p><b>Deco Header</b>                  Length - 24 Foot                  Mill Finish - DCB006124                  White - DCB006324</p> 	<p><b>10 X 2" Right Hand Screw #8 410 Stainless 8685000</b>                  Sold in packs of 1000</p> 
<p><b>10 X 2" Left Hand Screw #8 410 Stainless 8685000LT</b>                  Sold in packs of 1000</p> 	<p><b>1/4" X 1" Square Drive Screw SMS Stainless 8685002</b>                  Sold in packs of 500</p> 	<p><b>Large Camel Bracket 2488000</b></p> 
<p><b>Tube 6800024</b>                  Length - 24 Foot</p> 	<p><b>Ring 2502000</b></p> 	<p><b>Thumbscrew 2504000</b></p> 
<p><b>Lock Pins 2492000</b></p> 	<p><b>7/8" Serrated Tube 1402120</b>                  20' Anodized</p> 	<p><b>1" Serrated Tube 1400120</b>                  20' Anodized</p> 

# Pool & Patio

## Shade Awnings Non-Code

### Shade Awning

Shade Awnings give protection without eliminating the view.

*\* Does not meet hurricane protection code*



### Clamshell Awning

Clamshell Awnings provide U.V. Ray protection and can be locked-down for added security.

*\* Does not meet hurricane protection code*

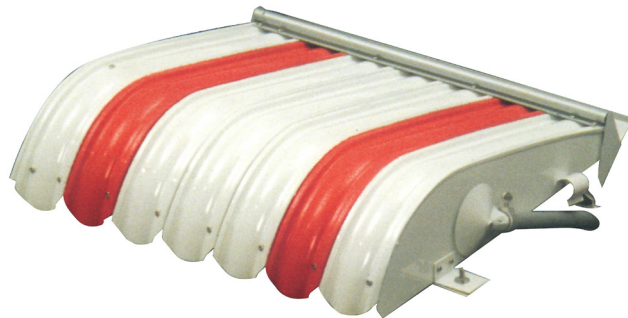

### Female Shade Awning Hinge

.398 lb/ft

Part #	Color	Size
1408321	Silver	21'

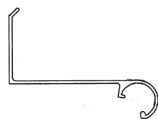

### Male Shade Awning Header

.172 lb/ft

Part #	Color	Size
1406321	Silver	21'



# Windows & Doors

Shade Awnings/Windows & Doors



## Windows



## Doors



# Pergola

## Elitewood™ Ultra Series

Elitewood's™ unique metallic composition offers not just comfort, but complete peace of mind:

- Little to no maintenance
- Total weather resistance
- No cracking, warping, or splitting
- No need for painting
- Fire resistant
- Termite resistant
- Unsurpassed durability that will preserve its beauty for years to come.

Ultra Series is embossed with a rough hewn deep driftwood texture that resembles the natural appearance and beauty of real wood without the many problems associated with wood. Ultra Series Patio Covers feature design diversity, and numerous optional extras.

Create the perfect shade cover to enhance the beauty of your home and lifestyle. Choosing an Elitewood™ Ultra Series shade cover is not only an investment that provides return on your home's value, but creates the perfect environment for any occasion.



### Standard Colors



White



Ivory



Beige



Adobe



Desert Sand



Brown



Wheat

### End Cut Options



Scallop



Bevel



Miter



Corbel



# Pergola

## Elitewood™ Classic Series

Elitewood's™ unique metallic composition offers not just comfort, but complete peace of mind: Little to no maintenance; Total weather resistance; No cracking, warping, or splitting; No need for painting; fire resistant, termite resistant and unsurpassed durability that will preserve its beauty for years to come.

Four Seasons Building Products presents the Elitewood™ Classic Series. Classic Series Lattice is embossed with a rough hewn cedar look that portrays the natural appearance and beauty of wood without the issues associated with wood. With Classic Series Lattice's upgraded features, design diversity, and numerous optional extras, create the perfect shade cover to enhance the beauty of your home and lifestyle.

Choosing an Elitewood™ Classic Series shade cover is not only an investment that provides return on your home's value, but creates the perfect environment for any occasion.



### Standard Colors



Adobe



Almond



Beige



Brown



Cameo



Champagne



Desert Sand



White

### End Cut Options



Scallop



Bevel



Miter



Corbel



# Pergola

## Naturewood Pergola

*The ultimate shelter patio cover that offers style and elegance to enhance your outdoor living area.*

**Sequoia Package** - The Sequoia Package combines the Naturewood Pergola system with the Elite insulated roof system to protect your outdoor living area from the elements and keeping a cool environment under the solid roof structure. Electrical raceway concealed in the Elite roof can support lighting or ceiling fans underneath the solid roof structure. The Sequoia Package is available in either a 3", 4" or 6" thickness, depending upon your geographical location. Specifically, the thickness required is based upon snow load, wind load and other engineering and customer requirements.

**Impenetrable, Non-staining Paint Coating** - Featuring the Duracoat XT-10 Weatherguard Paint Coating which is a low-maintenance, highly durable polyester coating great for interior and exterior applications. The XT-10 series is formulated with a proprietary composite polyester resin for resistance to U.V. degradation to prevent chalking and fading in severe environments.

**Custom Designed Shade Settings** - The Naturewood Pergola gives you the flexibility to determine the amount of shade you desire. Any combination of shade and sunlight from 40%, 60% to 100% total shade can also be created while the other portion allows as much sunlight as desired.



### Standard Colors and Embossing



White

Desert Sand

Almond Sand

Adobe Clay

Spanish Brown

Bronze Cedar

### End Cut Options



Scallop

Corbel

Mitered

Beveled



# Pergola

## Purlins (Lattice)

**.024 (2 x 2) Lattice**

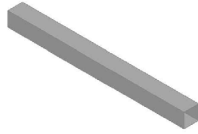

**.024 (2 x 3) Lattice**

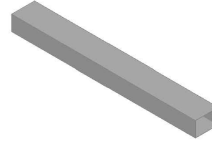

## Post, Header & Rafter Beams

**.024 (3 x 3) Post**

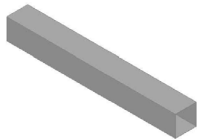

**.024 (2 x 6.5) Rafter**

Mitered, Scallop & Corbel



**.040 (3 x 8) Beam**

Mitered, Scallop & Corbel

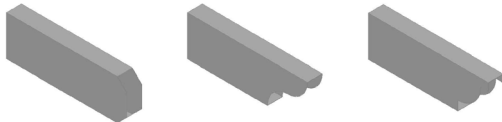

**.024 Ledger Cap**

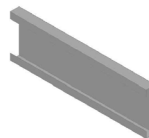

# Caps & Covers

**2" Bevel Cap**

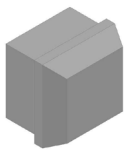

**2 x 3" Bevel Cap**



**3" Bevel Cap**



**2 x 6.5" Miter Cap**



**2 x 6.5" Bevel Cap**

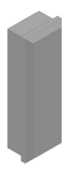

**2 x 6.5" Corbel Cap**



**2 x 6.5" Scallop Cap**



**3 x 8" Miter Cap**



**3 x 8" Bevel Cap**

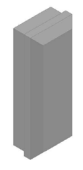

**3 x 8" Corbel Cap**



**3 x 8" Scallop Cap**



**5/8" Hole Plug**

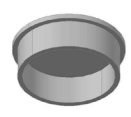

**.024 (2 x 6.5) Rafter Tail**  
Mitered, Scallop & Corbel



# Pergola

## Connectors

### 3" Top Post Bracket

Mill Finish



### 3" Bottom Post Bracket

Mill Finish



### 2 x 6.5" Rafter Hanger

Mill Finish



### 2 x 6.5" Rafter Hanger Header Bracket

Mill Finish



### Steel C-Beam Insert

18" and 20"

Mill Finish

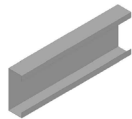

### 2 x 6.5" Foam Insert

8", 10" and 12"

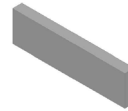

## Elbows, Splices & Down Spouts

### 2 x 3" Downspout (Cedar Embossed)

8' & 10'



### 2 x 2" Splice

Clear, Spanish Brown



### 2 x 3" Splice

Clear

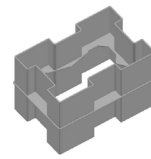

### 2 x 3" Elbows

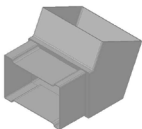

### 2 x 3" Drop Outlet

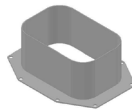

# Fencing & Railing



Regal ideas

# Decking



# Siding, Soffit & Accessories

## Contractors Choice

**D4** (Call local branch for availability)

Color	Part #	Color	Part #	
	Autumn Beige	SP ORDER	Natural Almond	SP ORDER
	Classic Cream	SP ORDER	Sandtone	SP ORDER
	Delray Sand	SP ORDER	Sandy Tan	SP ORDER
	Dover White	SP ORDER	Savannah Blue	SP ORDER
	Georgian Gray	SP ORDER	Silver Mist	SP ORDER
	Graphite Gray	SP ORDER	Spanish Olive	SP ORDER
	Irish Thistle	SP ORDER	Stone Mountain Clay	SP ORDER
	Island Pearl	SP ORDER		

**D4.5 Dutch Lap** (Call local branch for availability)

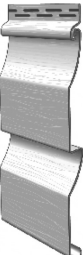
Color	Part #	Color	Part #	
	Autumn Beige	21VF110ABP	Natural Almond	21VF110NAP
	Classic Cream	21VF110CCP	Sandtone	21VF110
	Delray Sand	21VF110DSP	Sandy Tan	21VF110STP
	Dover White	21VF110DWP	Savannah Blue	21VF110SBP
	Georgian Gray	21VF110GGP	Silver Mist	21VF110SIP
	Graphite Gray	21VF110GRP	Spanish Olive	21VF110SOP
	Irish Thistle	21VF110ITP	Stone Mountain Clay	21VF110SMP
	Island Pearl	21VF110IPP		

**D5** (Call local branch for availability)

Color	Part #	Color	Part #	
	Autumn Beige	21VF135ABP	Natural Almond	21VF135NAP
	Classic Cream	21VF135CCP	Rich Moca	21VF135RMP
	Delray Sand	21VF135DSP	Sandtone	21VF135SDP
	Dover White	21VF135DWP	Sandy Tan	21VF135STP
	Georgian Gray	21VF135GGP	Savannah Blue	21VF135SBP
	Graphite Gray	SP ORDER	Silver Mist	21VF135SIP
	Heritage Linen	21VF135HLP	Southern Cypress	21VF135SCP
	Irish Thistle	21VF135ITP	Spanish Olive	21VF135SOP
Island Pearl	21VF135IPP	Stone Mountain Clay	21VF135SMP	

**T3** (Call local branch for availability)

Color	Part #	Color	Part #	
	Autumn Beige	SP ORDER	Natural Almond	SP ORDER
	Classic Cream	SP ORDER	Sandtone	SP ORDER
	Delray Sand	SP ORDER	Sandy Tan	SP ORDER
	Dover White	21VF169DWP	Savannah Blue	SP ORDER
	Georgian Gray	SP ORDER	Silver Mist	SP ORDER
	Graphite Gray	SP ORDER	Spanish Olive	SP ORDER
	Irish Thistle	SP ORDER	Stone Mountain Clay	SP ORDER
	Island Pearl	SP ORDER		

# Siding, Soffit & Accessories

## ClimaForce High Perf. Foam Insulated Siding

### D4

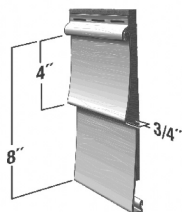

Color	Part #	Color	Part #
Classic Cream	SP ORDER	Sandy Tan	SP ORDER
Dover White	SP ORDER	Silver Mist	SP ORDER
Georgian Gray	SP ORDER	Stone Mountain Clay	SP ORDER
Graphite Gray	SP ORDER	Canyon	SP ORDER
Irish Thistle	SP ORDER	Granite	SP ORDER
Island Pearl	SP ORDER	River Bend	SP ORDER
Natural Almond	SP ORDER	Willow	SP ORDER

### D5 Dutch Lap

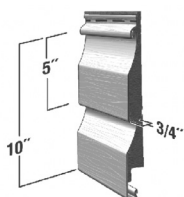

Color	Part #	Color	Part #
Classic Cream	SP ORDER	Sandy Tan	SP ORDER
Dover White	SP ORDER	Silver Mist	SP ORDER
Georgian Gray	SP ORDER	Stone Mountain Clay	SP ORDER
Graphite Gray	SP ORDER	Canyon	SP ORDER
Irish Thistle	SP ORDER	Granite	SP ORDER
Island Pearl	SP ORDER	River Bend	SP ORDER
Natural Almond	SP ORDER	Willow	SP ORDER

### D6

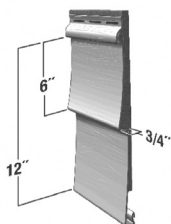

Color	Part #	Color	Part #
Classic Cream	SP ORDER	Sandy Tan	SP ORDER
Dover White	SP ORDER	Silver Mist	SP ORDER
Georgian Gray	SP ORDER	Stone Mountain Clay	SP ORDER
Graphite Gray	SP ORDER	Canyon	SP ORDER
Irish Thistle	SP ORDER	Granite	SP ORDER
Island Pearl	SP ORDER	River Bend	SP ORDER
Natural Almond	SP ORDER	Willow	SP ORDER

### S7

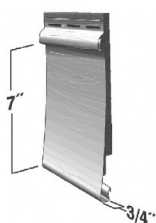

Color	Part #	Color	Part #
Classic Cream	SP ORDER	Sandy Tan	SP ORDER
Dover White	SP ORDER	Silver Mist	SP ORDER
Georgian Gray	SP ORDER	Stone Mountain Clay	SP ORDER
Graphite Gray	SP ORDER	Canyon	SP ORDER
Irish Thistle	SP ORDER	Granite	SP ORDER
Island Pearl	SP ORDER	River Bend	SP ORDER
Natural Almond	SP ORDER	Willow	SP ORDER

# Ashton Heights

## D4

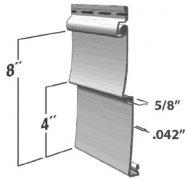

Color	Part #	Color	Part #
Autumn Beige	SP ORDER	Amber	SP ORDER
Classic Cream	SP ORDER	Flint	SP ORDER
Dover White	SP ORDER	Hazelnut	SP ORDER
Georgian Gray	SP ORDER	Irish Thistle	SP ORDER
Heritage Linen	SP ORDER	Southern Cypress	SP ORDER
Island Pearl	SP ORDER	Stone Mountain Clay	SP ORDER
Natural Almond	SP ORDER	Briarwood	SP ORDER
Rich Mocha	SP ORDER	Old Dublin*	SP ORDER
Sandtone	SP ORDER	Pewter	SP ORDER
Sandy Tan	SP ORDER	Sagebrook	SP ORDER
Savannah Blue	SP ORDER	Teak*	SP ORDER
Silver Mist	SP ORDER	Twilight Shadow*	SP ORDER
Spanish Olive	SP ORDER	Wedgewood	SP ORDER

## D4 Dutch Lap

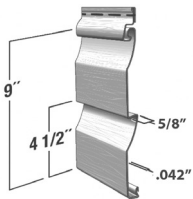

Color	Part #	Color	Part #
Autumn Beige	SP ORDER	Amber	SP ORDER
Classic Cream	SP ORDER	Flint	SP ORDER
Dover White	SP ORDER	Hazelnut	SP ORDER
Georgian Gray	SP ORDER	Irish Thistle	SP ORDER
Heritage Linen	SP ORDER	Southern Cypress	SP ORDER
Island Pearl	SP ORDER	Stone Mountain Clay	SP ORDER
Natural Almond	SP ORDER	Briarwood	SP ORDER
Rich Mocha	SP ORDER	Old Dublin*	SP ORDER
Sandtone	SP ORDER	Pewter	SP ORDER
Sandy Tan	SP ORDER	Sagebrook	SP ORDER
Savannah Blue	SP ORDER	Teak*	SP ORDER
Silver Mist	SP ORDER	Twilight Shadow*	SP ORDER
Spanish Olive	SP ORDER	Wedgewood	SP ORDER

## D5

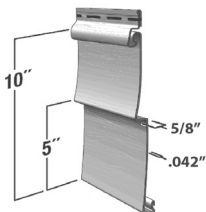

Color	Part #	Color	Part #
Autumn Beige	SP ORDER	Amber	SP ORDER
Classic Cream	SP ORDER	Flint	SP ORDER
Dover White	SP ORDER	Hazelnut	SP ORDER
Georgian Gray	SP ORDER	Irish Thistle	SP ORDER
Heritage Linen	SP ORDER	Southern Cypress	SP ORDER
Island Pearl	SP ORDER	Stone Mountain Clay	SP ORDER
Natural Almond	SP ORDER	Briarwood	SP ORDER
Rich Mocha	SP ORDER	Old Dublin*	SP ORDER
Sandtone	SP ORDER	Pewter	SP ORDER
Sandy Tan	SP ORDER	Sagebrook	SP ORDER
Savannah Blue	SP ORDER	Teak*	SP ORDER
Silver Mist	SP ORDER	Twilight Shadow*	SP ORDER
Spanish Olive	SP ORDER	Wedgewood	SP ORDER

# Siding, Soffit & Accessories

## Camden Pointe

### D4 Dutch Lap

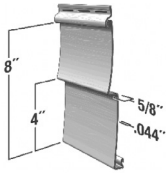

Color	Part #	Color	Part #
Classic Cream	SP ORDER	Spanish Olive	SP ORDER
Dover White	SP ORDER	Stone Mountain Clay S	P ORDER
Georgian Gray	SP ORDER	Canyon	SP ORDER
Graphite Gray	SP ORDER	Cypress	SP ORDER
Irish Thistle	SP ORDER	Granite	SP ORDER
Island Pearl	SP ORDER	River Bend	SP ORDER
Natural Almond	SP ORDER	Sedona Red	SP ORDER
Sandy Tan	SP ORDER	Willow	SP ORDER
Silver Mist	SP ORDER		

### D4.5 Dutch Lap

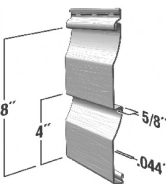

Color	Part #	Color	Part #
Classic Cream	SP ORDER	Silver Mist	SP ORDER
Dover White	SP ORDER	Spanish Olive	SP ORDER
Georgian Gray	SP ORDER	Stone Mountain Clay S	P ORDER
Graphite Gray	SP ORDER	Canyon	SP ORDER
Irish Thistle	SP ORDER	Cypress	SP ORDER
Island Pearl	SP ORDER	Granite	SP ORDER
Natural Almond	SP ORDER	River Bend	SP ORDER
Sandy Tan	SP ORDER	Willow	SP ORDER

### D5

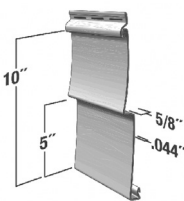

Color	Part #	Color	Part #
Classic Cream	SP ORDER	Silver Mist	SP ORDER
Dover White	SP ORDER	Spanish Olive	SP ORDER
Georgian Gray	SP ORDER	Stone Mountain Clay S	P ORDER
Graphite Gray	SP ORDER	Canyon	SP ORDER
Irish Thistle	SP ORDER	Cypress	SP ORDER
Island Pearl	SP ORDER	Granite	SP ORDER
Natural Almond	SP ORDER	River Bend	SP ORDER
Sandy Tan	SP ORDER	Willow	SP ORDER

### D5 Dutch Lap

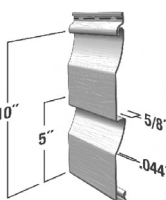

Color	Part #	Color	Part #
Classic Cream	SP ORDER	Silver Mist	SP ORDER
Dover White	SP ORDER	Spanish Olive	SP ORDER
Georgian Gray	SP ORDER	Stone Mountain Clay S	P ORDER
Graphite Gray	SP ORDER	Canyon	SP ORDER
Irish Thistle	SP ORDER	Cypress	SP ORDER
Island Pearl	SP ORDER	Granite	SP ORDER
Natural Almond	SP ORDER	River Bend	SP ORDER
Sandy Tan	SP ORDER	Willow	SP ORDER

# Vortex Extreme

## D4

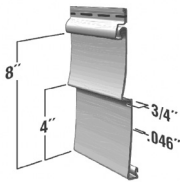

Color	Part #	Color	Part #
Autumn Beige	SP ORDER	Savannah Blue	SP ORDER
Classic Cream	SP ORDER	Silver Mist	SP ORDER
Delray Sand	SP ORDER	Spanish Olive	SP ORDER
Dover White	SP ORDER	Stone Mountain Clay	SP ORDER
Georgian Gray	SP ORDER	Canyon	SP ORDER
Graphite Gray	SP ORDER	Granite	SP ORDER
Rish Thistle	SP ORDER	River Bend	SP ORDER
Island Pearl	SP ORDER	Sedona Red	SP ORDER
Natural Almond	SP ORDER	Willow	SP ORDER
Sandy Tan	SP ORDER		

## D4.5 Dutch Lap

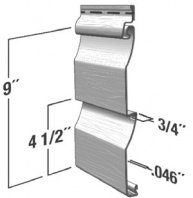

Color	Part #	Color	Part #
Autumn Beige	SP ORDER	Savannah Blue	SP ORDER
Classic Cream	SP ORDER	Silver Mist	SP ORDER
Delray Sand	SP ORDER	Spanish Olive	SP ORDER
Dover White	SP ORDER	Stone Mountain Clay	SP ORDER
Georgian Gray	SP ORDER	Canyon	SP ORDER
Graphite Gray	SP ORDER	Granite	SP ORDER
Rish Thistle	SP ORDER	River Bend	SP ORDER
Island Pearl	SP ORDER	Sedona Red	SP ORDER
Natural Almond	SP ORDER	Willow	SP ORDER
Sandy Tan	SP ORDER		

## D5

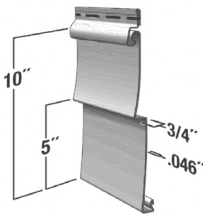

Color	Part #	Color	Part #
Autumn Beige	SP ORDER	Sandy Tan	SP ORDER
Classic Cream	SP ORDER	Savannah Blue	SP ORDER
Delray Sand	SP ORDER	Silver Mist	SP ORDER
Dover White	SP ORDER	Spanish Olive	SP ORDER
Georgian Gray	SP ORDER	Stone Mountain Clay	SP ORDER
Graphite Gray	SP ORDER	Canyon	SP ORDER
Rish Thistle	SP ORDER	Granite	SP ORDER
Island Pearl	SP ORDER	River Bend	SP ORDER
Natural Almond	SP ORDER	Willow	SP ORDER

# Siding, Soffit & Accessories

## Soffit

### D5 Soffit Solid and Perforated

Color	Solid	Vented	Color	Solid	Vented
Classic Cream	34VF144CC	34VF145CC	Sandy Tan	34VF144ST	34VF145ST
Delray Sand	SP ORDER	SP ORDER	Savannah Blue	SP ORDER	SP ORDER
Dover White	34VF144DW	34VF145DW	Silver Mist	34VF144SM	34VF145SM
Dover White (Enviroback)	34VF144EBW	SP ORDER	Spanish Olive	SP ORDER	SP ORDER
Georgian Gray	34VF144GG	34VF145GG	Stone Mountain Clay	34VF144SC	34VF145SC
Graphite Gray	SP ORDER	SP ORDER			
Irish Thistle	SP ORDER	SP ORDER			
Island Pearl	34VF144IP	34VF145IP			
Natural Almond	34VF144NA	34VF145NA			

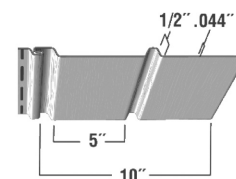

### T4 Soffit, Solid, Centervent (Special Order), Full Vent

Color	Solid	Vented	Color	Solid	Vented
Autumn Beige	34VF230AB	34VF231AB	Savannah Blue	34VF230SB	34VF231SB
Classic cream	34VF230CC	34VF231CC	Silver Mist	34VF230MT	34VF231MT
Delray Sand	34VF230DS	34VF231DS	Spanish Olive	34VF230SO	34VF231SO
Dover White*	34VF230DW	34VF231DW	Stone Mountain Clay*	34VF230SM	34VF231SM
Enviroback White	34VF230EBW	34VF231EBW	Canyon	SP ORDER	SP ORDER
Georgian Gray	34VF230GG	34VF231GG	Granite	SP ORDER	SP ORDER
Graphite Gray	SP ORDER	SP ORDER	River Bend	SP ORDER	SP ORDER
Heritage Lines	34VF230HL	34VF231HL	Sedona Red	SP ORDER	SP ORDER
Irish Thistle	34VF230IT	34VF231IT	Willow	SP ORDER	SP ORDER
Island Pearl	34VF230IP	34VF231IP	Musket Brown	34VF230MB	34VF231MB
Natural Almond	34VF230NA	34VF231NA			
Sandytone	34VF230SD	34VF231SD			
Sandy Tan*	34VF230ST	34VF231ST			

\*available in Centervent

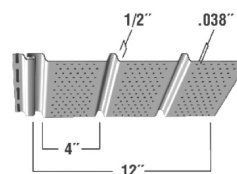

### 7" Beaded Solid and Vented

Color	Solid	Vented
Dover White	34VF157DW	34VF158DW
Island Pearl	SP ORDER	SP ORDER
Natural Almond	SP ORDER	SP ORDER
Sandy Tan	SP ORDER	SP ORDER
Stone Mountain Clay	SP ORDER	SP ORDER

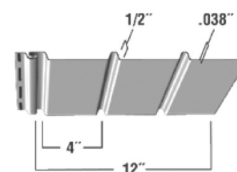

### Variform Proguard Vinyl Skirting

Description	Part #
Vented Skirting White	31VF422WH
Solid Skirting White	31VF420WH
Bottom Rail White	VVB0300
Back Rail White	VVBA300
Top Front Rail White	VVTF300
Spike and Screw Kit	VVS000

(Also Available in Cream, Clay, Gray, Pearl, Tan)

# Channels, Trim and Cornerpost

## 1/2" J Channel

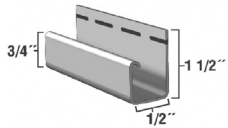

Color	Part #	Color	Part #
Autumn Beige	26VF336AB	Savannah Blue	26VF336SB
Classic Cream	26VF336CC	Silver Mist	26VF336SM
Delray Sand	26VF336DS	Spanish Olive	26VF336SO
Dover White	26VF336DW	Stone Mountain Clay	26VF336SC
Georgian Gray	26VF336GG	Canyon	SP ORDER
Graphite Gray	SP ORDER	Granite	SP ORDER
Irish Thistle	26VF336IT	River Bend	SP ORDER
Island Pearl	26VF336IP	Sedona Red	SP ORDER
Natural Almond	26VF336NA	Willow	SP ORDER
Sandy Tan	26VF336ST	Musket Brown	26VF336MB

## 1/2" H-Mold

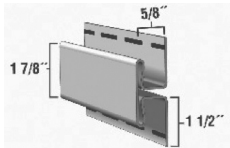

Color	Part #	Color	Part #
Dover White	26VF330DW	Sandy Tan	SP ORDER
Island Pearl	SP ORDER	Stone Mountain Clay	SP ORDER
Natural Almond	SP ORDER		

## Undersill Trim

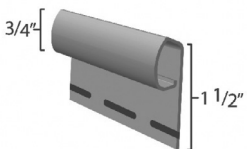

Color	Part #	Color	Part #
Autumn Beige	26VFUSTAB	Savannah Blue	26VFUSTSB
Classic Cream	26VFUSTCC	Silver Mist	SP ORDER
Delray Sand	26VFUSTDS	Spanish Olive	SP ORDER
Dover White	26VFUSTDW	Stone Mountain Clay	26VFUSTSM
Georgian Gray	26VFUSTGG	Canyon	SP ORDER
Graphite Gray	SP ORDER	Granite	SP ORDER
Irish Thistle	26VFUSTIT	River Bend	SP ORDER
Island Pearl	26VFUSTIP	Sedona Red	SP ORDER
Natural Almond	26VFUSTNA	Willow	SP ORDER
Sandy Tan	26VFUSTST		

## 1/2" F Channel

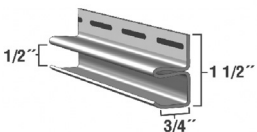

Color	Part #	Color	Part #
Autumn Beige	SP ORDER	Savannah Blue	SP ORDER
classic cream	SP ORDER	Silver Mist	SP ORDER
Delray Sand	SP ORDER	Spanish Olive	SP ORDER
Dover White	26VF339DW	Stone Mountain Clay	SP ORDER
Georgian Gray	26VF339GC	Canyon	SP ORDER
Graphite Gray	SP ORDER	Granite	SP ORDER
Irish Thistle	SP ORDER	River Bend	SP ORDER
Island Pearl	26VF339IP	Sedona Red	SP ORDER
Natural Almond	26VF339NA	Willow	SP ORDER
Sandy Tan	SP ORDER		

# Siding, Soffit & Accessories

## 1/4 J Channel

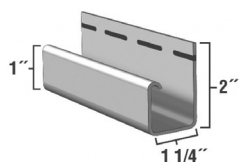

Color	Part #	Color	Part #
Autumn Beige	SP ORDER	Savannah Blue	SP ORDER
Classic Cream	SP ORDER	Silver Mist	SP ORDER
Delray Sand	SP ORDER	Spanish Olive	SP ORDER
Dover White	SP ORDER	Stone Mountain Clay	SP ORDER
Georgian Gray	SP ORDER	Canyon	SP ORDER
Graphite Gray	SP ORDER	Granite	SP ORDER
Irish Thistle	SP ORDER	River Bend	SP ORDER
Island Pearl	SP ORDER	Sedona Red	SP ORDER
Natural Almond	SP ORDER	Willow	SP ORDER
Sandy Tan	SP ORDER		

## Inside Corner Post

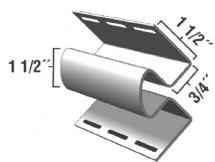

Color	Part #	Color	Part #
Autumn Beige	26VF364AB	Savannah Blue	26VF364SB
Classic Cream	26VF364CC	Silver Mist	26VF364SI
Delray Sand	SP ORDER	Spanish Olive	26VF364SO
Dover White	26VF364DW	Stone Mountain Clay	26VF364SM
Georgian Gray	26VF364GG	Canyon	SP ORDER
Graphite Gray	SP ORDER	Granite	SP ORDER
Irish Thistle	26VF364IT	River Bend	SP ORDER
Island Pearl	26VF364IP	Sedona Red	SP ORDER
Natural Almond	26VF364NA	Willow	SP ORDER
Sandy Tan	26VF364ST		

## Outside Corner Post

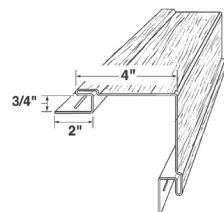
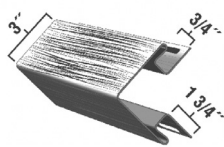

Color	Part #	Color	Part #
Autumn Beige	26VFOCP4AB	Savannah Blue	26VFOCP4SB
classic cream	26VFOCP4CC	Silver Mist	26VFOCP4SI
Delray Sand	26VFOCP4DS	Spanish Olive	26VFOCP4SO
Dover White	26VFOCP4DW	Stone Mountain Clay	26VFOCP4SM
Georgian Gray	26VFOCP4GG	Canyon	SP ORDER
Graphite Gray	26VFOCP4GG	Granite	SP ORDER
Irish Thistle	26VFOCP4IT	River Bend	SP ORDER
Island Pearl	26VFOCP4IP	Sedona Red	SP ORDER
Natural Almond	26VFOCP4NA	Willow	SP ORDER
Sandy Tan	26VFOCP4ST		

## Accessories

### 2 1/2" Window Casing White 12'

**Part #**

26VFJWFDW

### Vinyl Starter Strip 12'

**Part #**

26VF303

### Aluminum Starter Strip 12'

**Part #**

LB11772

### Flex J Channel White

**Part #**

26VF506DW

### Aluminum Siding Nails

Part #	Size	Quantity
LB06180	1 1/2"	1# Box
0150080025	2"	50# Box

### 1 1/4" Stainless Steel Trim Nails

Color	Part #
Autumn Beige	LB06810
Classic Cream	LB06811
Delray Sand	LB06818
Dover White	LB19400
Georgian Gray	LB06812
Graphite Gray	LB06819
Irish Thistle	LB06814
Island Pearl	LB06813
Natural Almond	LB06820
Sandy Tan	LB06815
Savannah Blue	LB06816
Silver Mist	LB06821
Spanish Olive	SP ORDER
Stone Mountain Clay	LB06817
Canyon	SP ORDER
Granite	SP ORDER
River Bend	SP ORDER
Sedona Red	SP ORDER
Willow	SP ORDER
Musket Brown	LB06660

\*0150080024-50lb

\*0150080054-5lb



### 1 3/4" Stainless Steel Trim Nails

Color	Part #
Hickory Brown	V440104
Almond	LB06829
Charcoal Gray	V440107
White	LB06828
Antique Ivory	V440105
Musket Brown	LB06827



### PVC Trim - Coils

Color	Part #
Classic Cream	38VF568CC
Delray Sand	38VF568OS
Dover White	4502008
Georgian Gray	38VF568GG
Graphite Gray	38VF568GR
Thistle	38VF568IT
Natural Almond	38VF568NA
Sandy Tan	38VF568ST
Savannah Blue	SP ORDER
Silver Mist	38VF568MT
Spanish Olive	SP ORDER
Stone Mountain Clay	38VF568SM

### Standard J-Blocks

Description	Part #
7" x 7" face	

### J-Block Fixture

Description	Part #
7-1/8" x 8 1/8" face	

### Large J-Block

Description	Part #
7" x 11" face	

### Split Recessed J-Block

Description	Part #
5 1/4" x 7" face	

### Mini J-Block

Description	Part #
6" x 4 3/8" face	

# Siding, Soffit & Accessories

## Meter Base J-Block

Description	Part #
-------------	--------

16 ½ x 15 ½" face

## E-Z Surface Mount Block

Description	Part #
-------------	--------

6 ¾" x 6 ¾" face

## Hooded Exhaust Vent

Description	Part #
-------------	--------

6 7/8" x 6 7/8" face

## Round Gable Vent

Description	Part #
-------------	--------

18", 22", 36"

## Rectangular Gable Vent

Description	Part #
-------------	--------

14 x 20, 18 x 24, 24 x 30

## Round Top Gable Vent

Description	Part #
-------------	--------

14 x 22, 24 x 34

## Octagonal Gable Vent

Description	Part #
-------------	--------

18", 22"

## Half-Round Gable Vent

Description	Part #
-------------	--------

34 x 22

## Square Gable Vent

Description	Part #
-------------	--------

14 x 14

## Vinyl Shutters 12" or 15" wide

Description	Part #
-------------	--------

Multiple Colors and Heights available

# Gable Vents & J-Blocks

## Standard Block (2-Piece)

### Description

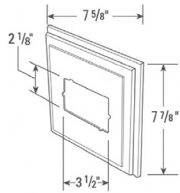

- Designed to flush mount light fixtures, receptacles, exterior faucets, etc.
- Front panel accented by attractive route red edge
- Can be used for all profiles of siding
- Easy to install for a finished appearance

## Electrical Block

### Description

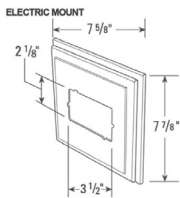

- A dual-purpose electrically approved mounting block engineered for both light fixtures and electrical receptacle applications
- E-Mount's electrical box is self-contained within the block, greatly simplifying wiring
- The result is a flush-mounted device that allows virtually no air infiltration

## Vent (2-Piece)

### Description

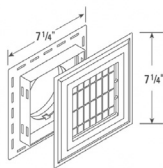

- Dryer vent or bathroom exhaust fan vent
- Flush mounts to surface
- Includes 10" tube with 4" - 3" reducer available

## Hooded Dryer Vent

### Description

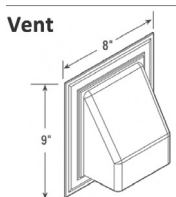

- Dryer vent or bathroom exhaust fan vent
- Colors packaged 1 per box
- Includes 10" tube with 4" - 3" reducer available

## Meter Box

### Description

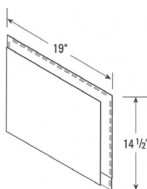

- For meters and extra large fixtures
- Colors packaged 1 per box
- White and paintable packaged 6 per box
- Fixed Ring

# Siding, Soffit & Accessories

## Gable Vents

### Description

- Premolded 1" J Channel with large nailing flange
- Fine detailed 2" wood-grained brick mold
- Unique, new design baffled louver keeps out rain gusts and snow

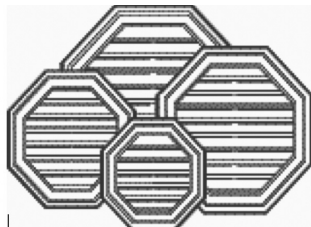
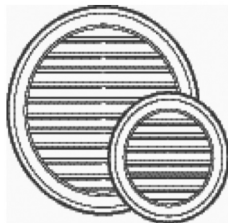

### Types

- 16" Octagon
- 15" x 22" Round Top Vertical
- 15" x 15" Square
- 15" x 22" Round Top Vertical
- 20" Octagon
- 30" Round
- 32" x 20" Round Top Vertical
- 20" x 26" Rectangle
- 32" x 20" Round Top Vertical

## Recessed Split Mount

### Description

- The ideal mount for remodeling
- Larger than the industry standard, it allows easier use of receptacles and faucets, as well as, more room for clear turning of faucet handle

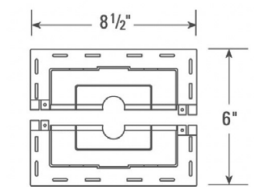

## Recessed Split Mount

### Description

- Fits on top of double 4" and double 5" lap siding
- Use for mounting fixtures after siding is installed

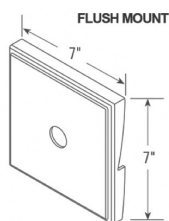

# Aluminum Soffit

## 12" Triple Four Builders 20/box

Color	Vented	Solid	Color	Solid	Vented
White (Frost)	LB05140	LB05130	Almond	LB05210	LB05200
Bone	LB05605	LB05175	New Ivory	LB05710	LB05711
Antique Ivory	LB05170	LB05160	White (Frost) CTR Vent	LB05280	N/A
Sandalwood	LB05602	LB05702			
Sandcastle	LB05604	LB05704			
Satin Gray	LB05607	LB05707			
Colonial Gray	LB05230	LB05220			
Brownstone	LB05608	LB05708			
Mist Green	LB05614	LB05714			
Hickory Brown	LB05190	LB05180			
Musket Brown	LB05250	LB05240			
Charcoal Gray	LB05270	LB05260			

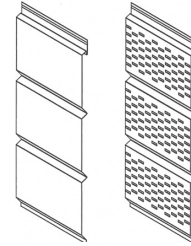

## 12" Triple Four Nasa 20/box - White Only

Color	Vented	Solid
Full Vent	LB05150	LB05155
Center Vent	LB05290	N/A
Musket	LB05240	LB05250

## 16" Quad Four Builders 20/box

Color	Vented	Solid	Color	Solid	Vented
White (Frost)	LB07600	LB07670	Charcoal Gray	LB07640	LB76041 Almond
Bone	LB76005	LB76705	LB07660	LB76061	
Antique Ivory	LB07650	LB07690	New Ivory	LB76006	LB07680
Sandalwood	LB76002	LB76702			
Sandcastle	LB76004	LB76704			
Satin Gray	LB76007	LB76707			
Colonial Gray	LB07630	LB07770			
Brownstone	LB76008	LB76708			
Mist Green	LB76014	LB76703			
Hickory Brown	LB07620	LB76000			
Musket Brown	LB76001	LB76701			

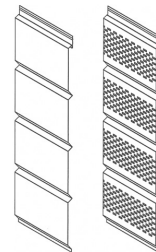

## 16" Quad Four Nasa 20/box

Color	Vented	Solid
White (Frost)	LB07610	N/A
Musket Brown	LB07612	N/A

## 16" Deep Vented 20/box

Color	Vented	Solid
White (Frost) ONLY	SPECIAL ORDER ONLY	

# Siding, Soffit & Accessories

## Aluminum Fascia

### 4" Deluxe Fascia 12ft - 25pcs/box

Color	Smooth	Woodgrain	Color	Smooth	Woodgrain
White (Frost) (No Rib)	LB10570	LB10550	Musket Brown	N/A	LB10611
White (Frost) (with Rib)	LB10560	N/A	Almond	N/A	LB10610
Bone	N/A	LB10615			
Antique Ivory	N/A	LB10600			
Sandalwood	N/A	LB10612			
Sandcastle	N/A	LB10614			
Satin Gray	N/A	LB10617			
Colonial Gray	N/A	LB10590			
Brownstone	N/A	LB10618			
Hickory Brown	N/A	LB10540			

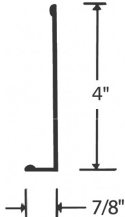

### 4" Commercial Fascia 12ft - 25pcs/box

Color	Smooth	Woodgrain
White	N/A	LB11810
Hickory Brown	N/A	LB11820
Musket Brown	N/A	LB10510

### 6" Deluxe Fascia 12ft - 25pcs/box

Color	Smooth	Woodgrain	Color	Smooth	Woodgrain
White (Frost)	LB10520	LB10630	Almond	N/A	LB10680
Bone	N/A	LB10675	Ivory	N/A	LB10676
Antique Ivory	N/A	LB10660	Frost (No Rib)	LB10530	N/A
Sandcastle	N/A	LB10674			
Satin Gray	N/A	LB10677			
Colonial Gray	N/A	LB10650			
Brownstone	N/A	LB10678			
Mist	N/A	LB10684			
Hickory Brown	N/A	LB10620			
Musket Brown	N/A	LB10670			
Gray	N/A	LB10640			

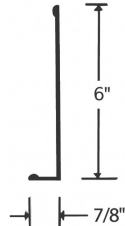

### 6" Commercial Fascia 12ft - 25pcs/box

Color	Smooth	Woodgrain
White	LB11846	
Hickory Brown	N/A	LB11840
Musket Brown	N/A	LB11841
Charcoal Gray	N/A	LB11842

### 8" Commercial Fascia 12ft - 25pcs/box

Color	Smooth	Woodgrain
White (Frost) (No Rib)	N/A	LB11850
White (Frost) (With Rib)	N/A	LB11150
Musket Brown (No Rib)	N/A	LB11861
Musket Brown (With Rib)	N/A	LB11871
Hickory Brown (No Rib)	N/A	LB11860
Hickory Brown (With Rib)	N/A	LB11859

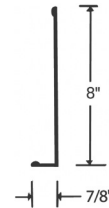

### 8" Deluxe Fascia 12ft - 25pcs/box

Color	Smooth	Woodgrain
White (No Rib)	N/A	LB10730

### 7½" Deluxe Fascia 12ft - 25pcs/box

Color	Smooth	Woodgrain
White	N/A	LB10700

### Texan Side Fascia - 17ft (Available in Houston, TX only)

Color	Smooth	Bronze
Ivory	N/A	LB10730

### Texan Side Fascia - 24ft (Available in Houston, TX only)

Color	Smooth	Bronze
Ivory	N/A	LB10730

## Aluminum Channels

### Old Fashioned 3/8 F Channel Comm

Part #	Color
White	LB10840
Almond	LB10805
Charcoal Gray	LB10806
Hickory Brown	LB10810
Antique Ivory	LB10825
Musket Brown	LB10835

# Siding, Soffit & Accessories

## ACM Aluminum J Channel 12ft 50pcs/box

Color	Smooth	Woodgrain	Color	Smooth	Woodgrain
White	LB10750	N/A	Charcoal Gray	LB10760	N/A
Bone	LB10755	N/A	Almond	LB10800	N/A
Antique Ivory	LB10780	N/A	New Ivory	LB10756	N/A
Sandalwood	LB10752	N/A			
Sandcastle	LB10754	N/A			
Satin Gray	LB10757	N/A			
Colonial Gray	LB10770	N/A			
Brownstone	LB10758	N/A			
Mist Green	LB10759	N/A			
Hickory Brown	LB10740	N/A			
Musket Brown	LB10790	N/A			

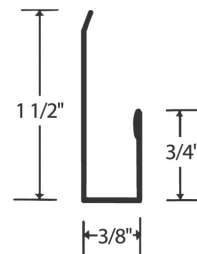

## 1/2" FACE Aluminum J Channel 12ft 50pcs/box

Color	Smooth	Woodgrain
White	LB10710	N/A

## 5/8" FACE Aluminum J Channel 12ft 50pcs/box

Color	Smooth	Woodgrain
White	LB10711	N/A

## ACM Aluminum F Channel 12ft 25pcs/box

Color	Smooth	Woodgrain	Color	Smooth	Woodgrain
White	LB10841	N/A	Charcoal Gray	LB10850	N/A
Bone	LB10852	N/A	Almond	LB10851	N/A
Antique Ivory	LB10844	N/A	New Ivory	LB10853	N/A
Sandalwood	LB10854	N/A			
Sandcastle	LB10846	N/A			
Satin Gray	B10847	N/A			
Colonial Gray	LB10843	N/A			
Brownstone	LB10848	N/A			
Mist Green	LB10849	N/A			
Hickory Brown	LB10820	N/A			
Musket Brown	LB10842	N/A			

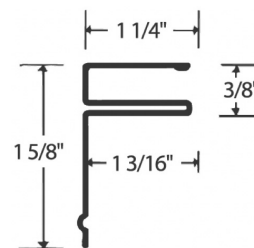

# Aluminum Drip Edge

## 1 3/4" Builders Drip Edge 12ft 50pcs/box

Color	Solid	Woodgrain
White	LB11020	LB10960
Bone	LB11045	LB11049
Antique Ivory	LB11010	LB11060
Colonial Gray	LB11030	LB11050
Hickory Brown	LB10920	LB10980
Musket Brown	LB11055	LB11070
Charcoal Gray	LB11040	LB11080

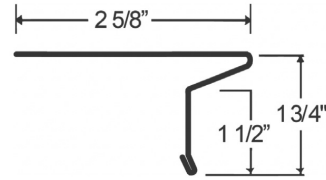

## 1 3/4" Deluxe Drip Edge 12ft 50pcs/box

Color	Solid	Woodgrain
White	LB10970	N/A
Hickory Brown	LB10950	N/A

## 2" Deluxe Drip Edge 12ft 50pcs/box

Color	Solid	Woodgrain
White	LB10870	LB10890
Antique Ivory	N/A	LB10880
Satin Gray	N/A	LB10877
Colonial Gray	N/A	LB10910
Hickory Brown	N/A	LB10900
Musket Brown	N/A	LB10871
Charcoal Gray	N/A	LB10940

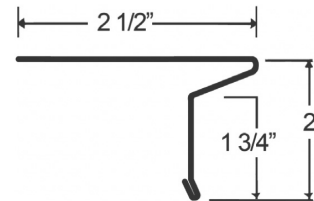

## 2" Commercial Drip Edge 12ft 50pcs/box

Color	Solid	Woodgrain
White	N/A	LB11805

## 2 1/2" .027 Premium Drip Edge 12ft 40pcs/box

Color	Solid	Woodgrain
White	LB11146	LB11144

# Siding, Soffit & Accessories

## 2 1/2" .018 Commercial Drip Edge 12ft 50pcs/box

Color	Solid	Woodgrain
White	LB11130	LB11100
Musket Brown	LB11142	LB11143
Almond	N/A	LB15030
Hickory Brown	LB11090	LB11110

## 2 1/2" .024 Deluxe Drip Edge 12ft 25pcs/box

Color	Solid	Woodgrain
White	LB10930	N/A

## James Hardie Fiber Cement Siding & Trim

Installed on over 8 million homes from coast to coast, James Hardie® fiber cement siding products are designed to resist the most extreme conditions while delivering long term beauty and lower maintenance. Enjoy the warm, natural look of wood with unprecedented peace of mind. It's easy to see what makes James Hardie the market leader.

With our unique formulation, we use the highest quality raw materials and proprietary additives for enhanced strength and moisture protection.

Top to bottom, our exterior product line is defined by excellent performance, aesthetics and design options.

Provide protection from the elements, showcase a homeowner's individual style and install peace of mind with exceptional warranties through a single, trusted manufacturer.



# Siding, Soffit & Accessories

## HardiePlank (Thickness - 5/16", Length - 12' Planks)



### Select Cedarmill®

Width	5.25"	6.25"	7.25"	8.25"	9.25"	12"
Exposure	4"	5"	6"	7"	8"	10.75"
Prime Pcs/Pallet	360	308	252	230	190	152
Pcs/Sq	25.0	20.0	16.7	14.3	12.5	9.3

*Only Available in prime*



### Smooth

Width	5.25"	6.25"	7.25"	8.25"	9.25"	12"
Exposure	4"	5"	6"	7"	8"	10.75"
Prime Pcs/Pallet	360	308	252	230	190	152
Pcs/Sq	25.0	20.0	16.7	14.3	12.5	9.3

*Only Available in prime*



*Beaded Cedarmill®*

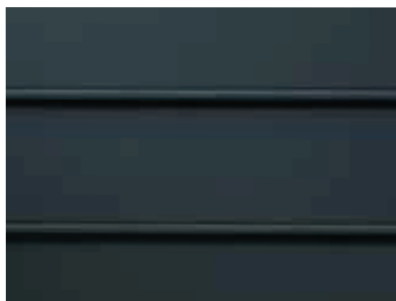

*Beaded Smooth*

### Beaded Cedarmill® & Beaded Smooth

Width	8.25"
Exposure	7"
Prime Pcs/Pallet	240
Pcs/Sq	14.3

*Only Available in prime*



*Custom Colonial Roughsawn®*



*Custom Colonial Smooth®*

### Custom Colonial Roughsawn® & Custom Colonial Smooth®

Width	8"
Exposure	6.75"
Prime Pcs/Pallet	240
Pcs/Sq	14.9

*Only Available in prime*

**HardiePanel** (Thickness - 5/16")**Select Cedarmill®**

Size	4' x 8'	4' x 10'
Prime Pcs/Pallet	50	50
Pcs/Sq	3.2	2.5

*Also available in Smooth, Stucco & Sierra 8*

*Only Available in primer*

**HardieShingle** (Thickness - 1/4")**Staggered Edge Panel**

Length	48"
Height	15.25"
Exposure	6"
Prime Pcs/Pallet	100
Sq/Pallet	2
Pcs/Sq	50.0

*Only Available in primer*

**Straight Edge Panel**

Length	48"
Height	15.25"
Exposure	7"
Prime Pcs/Pallet	86
Sq/Pallet	2
Pcs/Sq	43.0

*Only Available in primer*

**Half Rounds**

Length	48"
Height	15.25"
Exposure	7"
Prime Pcs/Pallet	86
Sq/Pallet	2
Pcs/Sq	43.0

*Only Available in primer*

# Siding, Soffit & Accessories

## HardieTrim (Length - 12' Boards)



Rustic Grain®

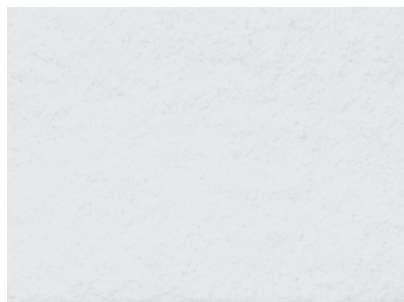

Smooth

### 4/4 Rustic Grain®

Thickness	3/4"	3/4"	3/4"	3/4"	3/4"	3/4"
Width	1.65"	3.5"	5.5"	7.25"	9.25"	11.25"
Prime Pcs/Pallet	405	322	184	138	115	92

Only Available in primer

### 5/4 Rustic Grain®

Thickness	1"	1"	1"	1"	1"
Width	3.5"	5.5"	7.25"	9.25"	11.25"
Prime Pcs/Pallet	238	136	102	85	68

Also available in Smooth

Only Available in primer

## Batten Boards

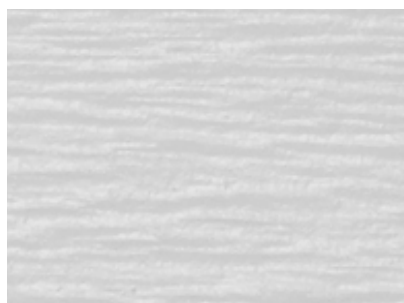

### Rustic Grain®

Thickness	3/4"
Width	2.5"
Prime Pcs/Pallet	190

Only Available in primer

## HardieSoffit (Thickness - ¼")

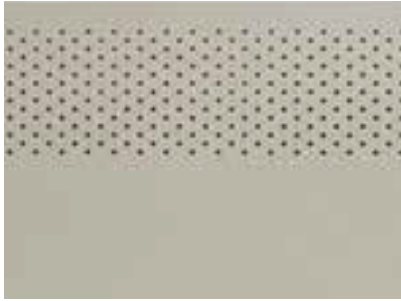

### Vented Smooth

Length	12'	12'	8'
Width	12"	16"	24"
Prime Pcs/Pallet	200	150	100

*Only Available in primer*

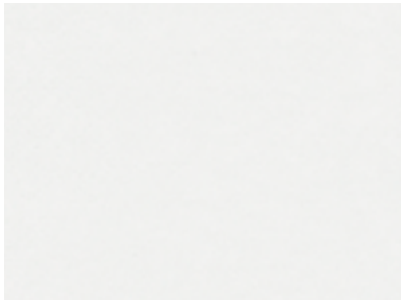

### Non-Vented Smooth

Length	12'	12'	8'	8'
Width	12"	16"	24"	48"
Prime Pcs/Pallet	200	150	100	50

*Also available in Cedarmill®*

*Only Available in primer*



## HardieWrap

### Weather Barrier

Thickness	11 mil		
Length	100'	100'	150'
Width	3'	9'	9'

### Flex Flashing

Thickness	60 mil	
Length	75'	75'
Width	6"	9"

### Pro-Flashing

Thickness	20 mil		
Length	75'	75'	75'
Width	4"	6"	9"

### Seam Tape

Thickness	3.2 mil
Length	164'
Width	1½"

# Siding, Soffit & Accessories

## Allura Fiber Cement Siding & Trim

Allura Primed Fiber Cement offers a textured and smooth look for your home with an industry best 50 year warranty. Allura Colormax matches the industry best 15 years on color warranty. Another benefit of Allura is thickness of panel. It is 5/16 thick (25% thicker than most competitors) which allows better rigidity (less sag), higher impact resistance and less breakage.

Allura products feature realistic wood grain and textures, come in an incredible array of colors and are paintable for unlimited design possibilities. Alluras primer is mixed and formulated by PPG Paint. The primer holds paint better than the competitor. Get the best for your home or project with Allura Fiber Cement now offered by Town & Country Industries.



## Allura Color Max Lap Siding (Thickness - 5/16", Length - 12' Planks)



### Traditional Cedar - Colors

Width	8.25"
Exposure	7"
Prime Pcs/Pallet	220
Pcs/Sq	14.3
<i>Colors listed below</i>	

### Available Colors



Autumn Red

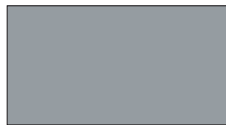

Pewter



Granite Gray



Natural Clay

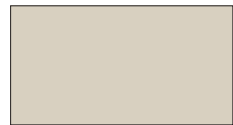

Savannah Wicker



Desert Tan



Linen



Taupe



Sable Brown



Bark



Snow



Sterling Gray



Flagstone



Pacific Blue



Knights Armor

*Other colors available by special order*

## Allura Trim (Length - 12' Boards)

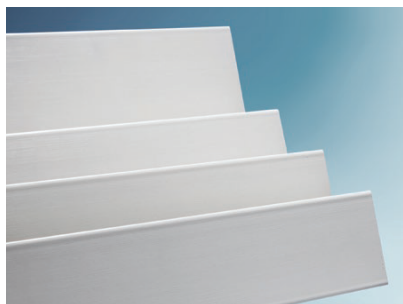

### 4/4 Smooth - White

Thickness	3/4"	3/4"	3/4"	3/4"	3/4"	3/4"
Width	2"	4"	6"	8"	10"	12"
Pcs/Pallet	462	240	147	115	88	72

### 5/4 Smooth - White

Thickness	1"	1"	1"	1"	1"
Width	4"	6"	8"	10"	12"
Pcs/Pallet	180	112	85	68	54

# Siding, Soffit & Accessories

## Allura Primed Lap Siding (Thickness - 5/16", Length - 12' Planks)



### Traditional Cedar - Primed

Width	7.25"	8.25"
Exposure	6"	7"
Prime Pcs/Pallet	252	230
Pcs/Sq	16.67	14.3



### Smooth - Primed

Width	7.25"	8.25"
Exposure	6"	7"
Prime Pcs/Pallet	252	230
Pcs/Sq	16.67	14.3

## Allura Primed Trim (Length - 12' Boards)

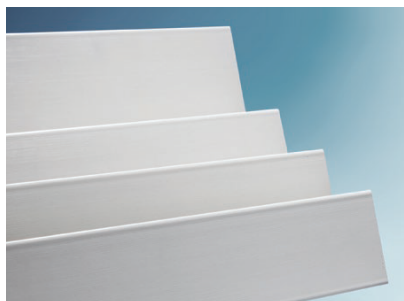

### 4/4 Reversible Woodgrain/Smooth - Primed

Thickness	3/4"	3/4"	3/4"	3/4"	3/4"	3/4"
Width	2"	4"	6"	8"	10"	12"
Prime Pcs/Pallet	506	250	161	115	96	78

### 5/4 Reversible Woodgrain/Smooth - Primed

Thickness	1"	1"	1"	1"	1"
Width	4"	6"	8"	10"	12"
Prime Pcs/Pallet	190	119	90	68	57

**Allura Soffit** (Thickness - 1/4")



**Vented Smooth**

Length	12'	12'	12'
Width	12"	16"	24"
Prime Pcs/Pallet	188	141	94

*Only Available in primed*

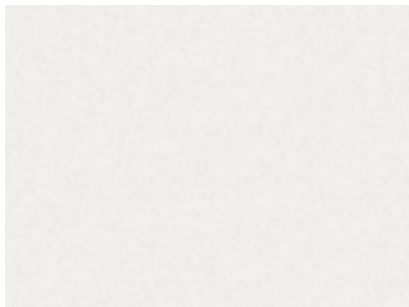

**Non-Vented Smooth**

Length	12'	12'	12'
Width	12"	16"	24"
Prime Pcs/Pallet	188	141	94

*Only Available in primed*

*Color is special order*

**Allura Panels** (Thickness - 5/16")

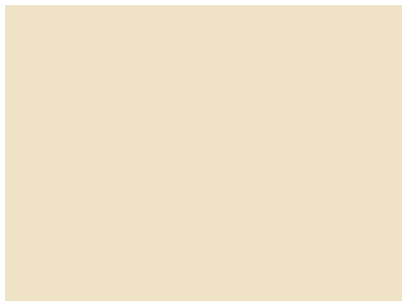

**Smooth**

Size	4' x 8'	4' x 10'
Prime Pcs/Unit	50	50

*Only Available in primed*



**Stucco**

Size	4' x 8'	4' x 10'
Prime Pcs/Unit	50	50

*Only Available in primed*

*Color is special order*

# Siding, Soffit & Accessories

## Allura Shake (Thickness - 1/4")



### Staggered Edge

Size	16" x 48"
Exposure	6
Prime Pcs/Pallet	129
Pcs/Sq	43

*Only Available in primed*

*Color is special order*



### Straight Edge

Size	16" x 48"
Exposure	7
Prime Pcs/Pallet	129
Pcs/Sq	43

*Only Available in primer*

*Color is special order*

## Accessories



1/4 Collated Roofing Nails E.G.  
Boxes of 7200 + Holder



Zinsser Primer by Rustoleum



Duo-sil Ultra



Gecko Clamps

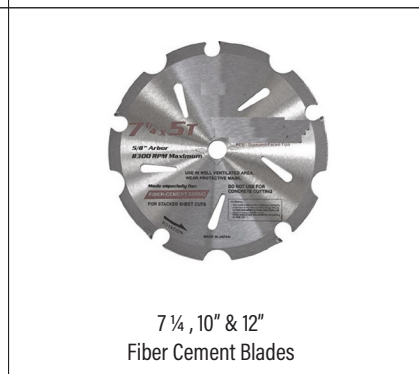

7 1/4 , 10" & 12"  
Fiber Cement Blades



MalcoTurboShear  
Fiber Cement Siding

## Accessories

				
<p>Sturdi-Starter</p>	<p>Fasco America Roofing Coil Nailer</p>	<p>ACRI-SHIELD® MAX Exterior Latex</p>		
				
<p>Universal Mount 8-1/2"x11" Dryer Vent</p>	<p>Oversized Mount 8-1/2"x15" Coach Lights</p>	<p>Split Mount 6' x 8 1/2" Spigots, Gas Lines, Bib Lines</p>	<p>Receptacle Mount 6" x 8-1/2" Electrical Boxes</p>	<p>UL Receptacle House Light Mount</p>
<p>Sturdi Mount Fiber Cement Mounts</p>				

### Fiber Cement Siding Cutter



### Fiber Cement Siding/Guillotine Angle Cutter

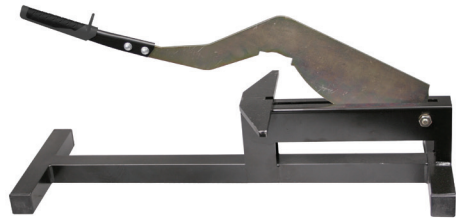

# Siding, Soffit & Accessories

## Everlast Composite Siding & Trim

The solid, authentic, high-end look of real cedar siding, with none of the problems of real wood, engineered wood, or fiber cement. Extremely durable and low maintenance mineral composite siding with polymer resins and acrylic colorants and virtually impervious to water, Ideal for any environment including coastal and freeze/thaw.

Everlast Siding never requires caulking or painting and is less than half the weight of fiber cement. Requires no proprietary or specialty tools to install and EZStack joinery speeds installation and ensures level. Stainless steel brackets allows the tightest seams and only ¼" expansion and contraction at the end of siding runs in sweltering heat or frigid cold . These benefits allows Everlast to offer a Limited Lifetime Warranty to original homeowner and an additional 50 year prorated warranty to any subsequent homeowner.

Choose from a beautiful palette of timeless colors.



**Everlast Standard Lap Siding** (Thickness - 1/16", Length - 12' Planks)



Width	8 3/8"
Exposure	6 7/8"
Pcs/Bundle	8
Pcs/Sq	14.5

Available Colors: Blue Spruce, Willow, Spanish Moss, Sand Dune, Misty Taupe, Chestnut, Saddlewood, Seaside Grey, Slate, Flagstone, Storm Grey, Natural White

**Everlast Board & Batten Siding** (Thickness - 3/4", Length - 12' Planks)

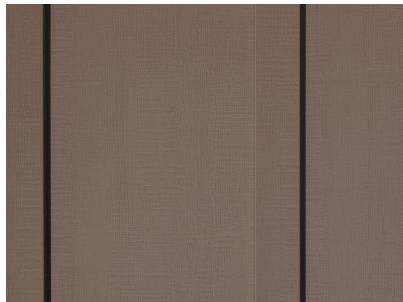

Width	12 1/2"
Exposure	11"
Pcs/Bundle	6
Pcs/Sq	9.2

Available Colors: Natural White, Sand Dune, Misty Taupe, Chestnut, Flagstone

**Available Colors**



Blue Spruce



Willow



Spanish Moss



Sand Dune

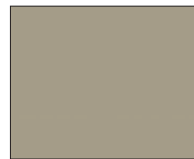

Misty Taupe

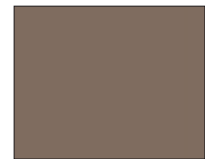

Chestnut



Saddle Wood

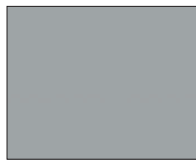

Seaside Grey

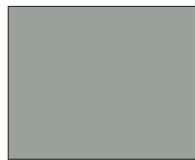

Slate



Flagstone



Storm Grey



Natural White

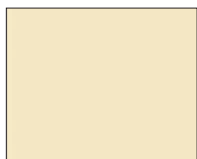

Antique Ivory



Harbor Blue

# Siding, Soffit & Accessories

## Everlast Trim

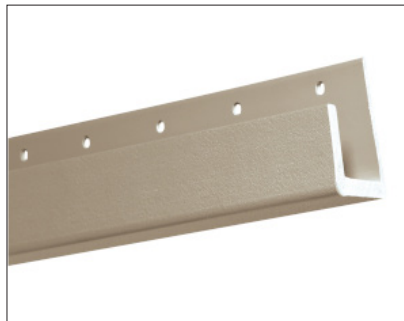

### 1 1/2" J Channel

Length 12' 6"  
Pcs/Bundle 20

*Available Colors: Blue Spruce, Willow, Spanish Moss, Sand Dune, Misty Taupe, Chestnut, Saddlewood, Seaside Grey, Slate, Flagstone, Storm Grey, Natural White, Antique Ivory, Harbor Blue*



### 3 1/2" Lineal

Length 12' 6"  
Pcs/Bundle 10

*Available Colors: Blue Spruce, Willow, Spanish Moss, Sand Dune, Misty Taupe, Chestnut, Saddlewood, Seaside Grey, Slate, Flagstone, Storm Grey, Antique Ivory, Harbor Blue*

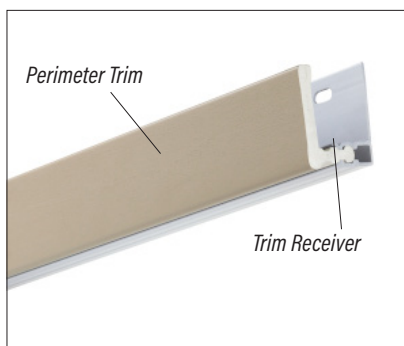

### Perimeter 1 1/2" Trim

Length 12' 6"  
Pcs/Bundle 15

*Available Colors: Blue Spruce, Willow, Spanish Moss, Sand Dune, Misty Taupe, Chestnut, Saddlewood, Seaside Grey, Slate, Flagstone, Storm Grey, Natural White, Antique Ivory, Harbor Blue*

### Trim Receiver

Length 12' 6"  
Pcs/Bundle 30

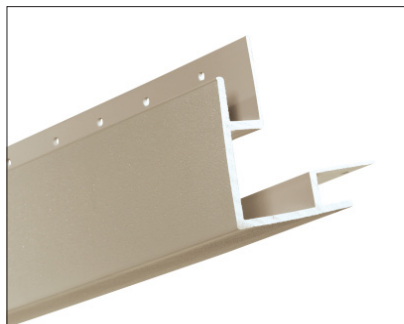

### 3 1/2" Outside Corner Post - 10'

Pcs/Bundle 3

*Available Colors: Blue Spruce, Willow, Spanish Moss, Sand Dune, Misty Taupe, Chestnut, Saddlewood, Seaside Grey, Slate, Flagstone, Storm Grey, Natural White, Antique Ivory, Harbor Blue*

### 3 1/2" Outside Corner Post - 20'

Pcs/Bundle 3

*Available Colors: Matte White*

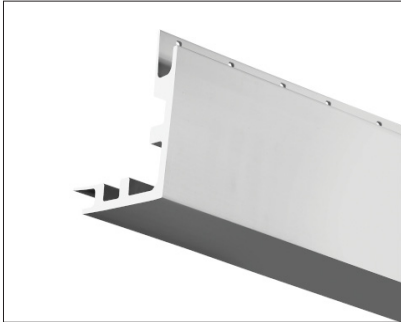

**5 1/2" Outside Corner Post - 10'**

Pcs/Bundle 3

Available Colors: *Matte White*

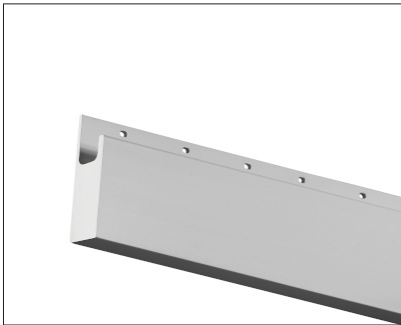

**3 1/2" Casing**

Length 12'

Pcs/Bundle 4

Available Colors: *Matte White*



**5 1/2" Casing**

Length 12'

Pcs/Bundle 4

Available Colors: *Matte White*

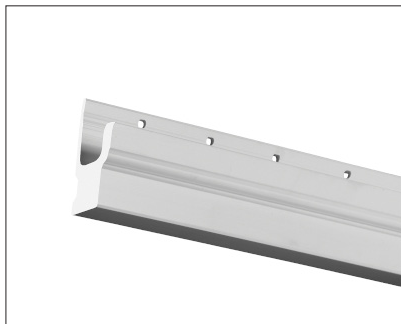

**Brickmould**

Length 17' 6"

Pcs/Bundle 8

Available Colors: *Matte White*

# Siding, Soffit & Accessories

## Everlast Accessories

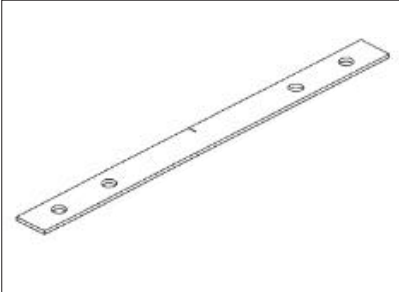

### Stainless Steel Metal Bracket Kits

Pieces per kit      25 brackets, 100 screws

*(1 box installs 3 - 5 squares of 6 7/8" siding)*

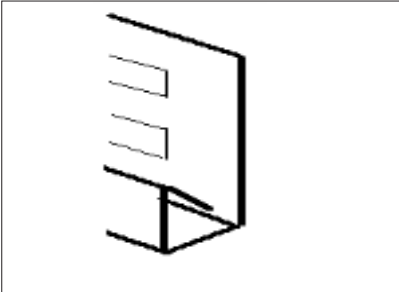

### Stainless Steel Starter Strip

Length                    10'  
Pieces per box        20

*(1 box installs 200 lineal feet of starter strip)*

## Stone Veneer



Using technology and innovation, Evolve Stone™ delivers a high-performing, beautiful stone veneer that is simply installed with a finish nailer.

## Rainware Components

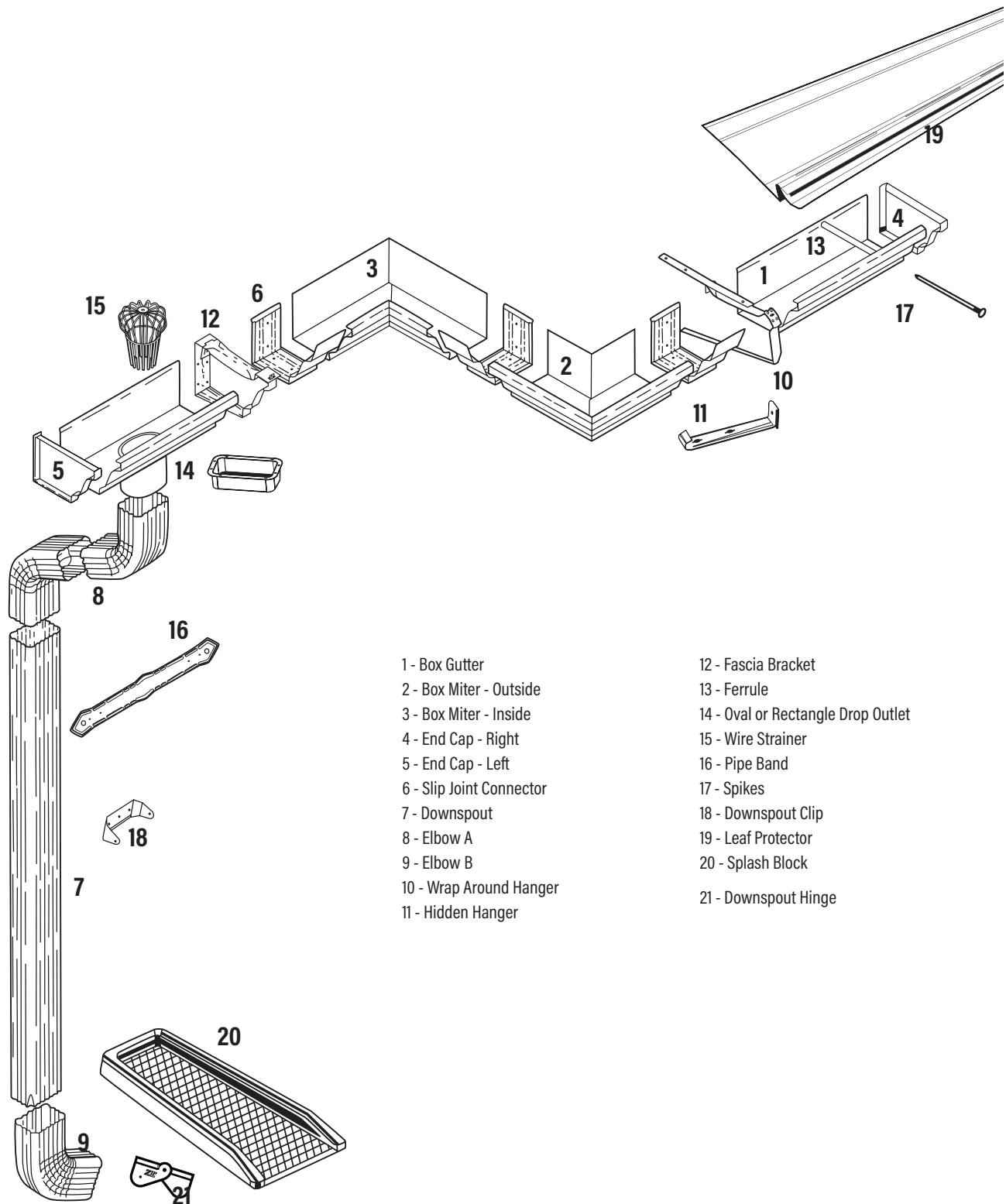

- 1 - Box Gutter
- 2 - Box Miter - Outside
- 3 - Box Miter - Inside
- 4 - End Cap - Right
- 5 - End Cap - Left
- 6 - Slip Joint Connector
- 7 - Downspout
- 8 - Elbow A
- 9 - Elbow B
- 10 - Wrap Around Hanger
- 11 - Hidden Hanger
- 12 - Fascia Bracket
- 13 - Ferrule
- 14 - Oval or Rectangle Drop Outlet
- 15 - Wire Strainer
- 16 - Pipe Band
- 17 - Spikes
- 18 - Downspout Clip
- 19 - Leaf Protector
- 20 - Splash Block
- 21 - Downspout Hinge

# Rainware

## Gutters

### Gutter Coil

Part #	Description	Colors Thickness	Nom. Gauge/ Pallet	Rolls/ Pallet
AGC21134	Aluminum 11' 3/4" Coil	(Listed Below)	0.027	3
AGC21134M2	Aluminum 11' 3/4" Coil	M2 (Premium Color)	0.027	3
AGC21178 --	Aluminum 11' 7/8" Coil	(Listed Below)	0.027	3
AGC21178M2	Aluminum 11' 7/8" Coil	M2 (Premium Color)	0.027	3
AGC215 --	Aluminum 15" Coil	(Listed Below)	0.027	2
AGC215M2	Aluminum 15" Coil	M2 (Premium Color)	0.027	2
AGC31134 --	Aluminum 11' 3/4" Coil	BK, WH, 80	0.032	3
AGC31178 --	Aluminum 11' 7/8" Coil	(Listed Below)	0.032	3
AGC315 --	Aluminum 15" Coil	(Listed Below)	0.032	2
*AGC318 ---	Aluminum 18" Coil	BZ/FR, ES/80, MB/FR, RB/WH, ST/CC	0.032	2

\*18" Gutter Coil cannot be sold in spin down quantities.



### Spin Down Gutter Coil

Part #	Description	Colors	Nom. Gauge/ Thickness	Pieces/ Pound
ASC21134 --	Aluminum 11' 3/4" Coil	(Listed Below)	0.027	Order by the lb.
ASC21178 --	Aluminum 11' 7/8" Coil	(Listed Below)	0.027	Order by the lb.
ASC215 --	Aluminum 15" Coil	(Listed next page)	0.027	Order by the lb.
ASC31134 --	Aluminum 11' 3/4" Coil	BK, WI, 80	0.032	Order by the lb.
ASC315 --	Aluminum 15" Coil	(Listed Below)	0.032	Order by the lb.
LSC61178	Galvalume 11' 7/8" Coil	Mill	26 ga	Order by the lb.
LSC615	Galvalume 15" Coil	Mill	26 ga	Order by the lb.
CSC21178	Copper 11' 7/8" Coil 1'/#	Copper	16 oz	Order by the lb.
CSC215	Copper 15" Coil	Copper	16 oz	Order by the lb.

**Note: Min. of 25 lbs./Max. of 150 lbs.** As an extra service, we'll spin down small quantities of a slow moving color on a special order basis. Minimum quantity is 25 lbs. Please note, once order is activated, no returns or changes can be made.



### K Gutter

Part #	Description
3088***	5" K Gutter
3096***	6" K Gutter

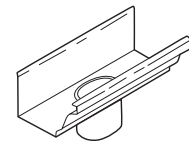

### Rainware & Accessories Colors

Color	Code	Color	Code	Color	Code	Color	Code	Color	Code	Color	Code
NX ALMOND	AD	BUCKSKIN	BU	DESERT SAND	DS	NX LINEN	LN	ROYAL BROWN	RB	TERRA BRONZE	TB
ALMOND	AL	CAMEO	CA	NX DUNE	CD	LINEN	LI	*RUSTIC COPPER	M2	VICTORIAN GREY	VG
ANTIQUE IVORY	AI	CHARCOAL GREY	CG	EGG SHELL	ES	MONTANA SUEDE	MS	SAGE	SA	WICKER	WI
BEAVER BROWN	BB	CLASSIC CREAM	CC	EVEREST	EV	MUSKET BROWN	MB	NX SAND STONE	SS	30 WHITE	WH
BLACK	BK	CLAY	CL	EVERGREEN	EG	NORWEGIAN WOOD	NW	SANDTONE	ST	80 WHITE	80
BRONZE	BZ	COPPER PENNY	CP	FROST	FR	PEBBLESTONE CLAY	PC	NX SIERRA	SI		
BROOKSTONE	BS	COUNTRY BLUE	CU	HARBOR GREY	HG	REDWOOD	RW	NX SILVER/SILVER GREY	SG		

\*Not available - .027: - 11'3/4" CP, MS - 11'7/8" ES, SA, SG - 15" SA | .032: - 11'3/4" CP, ES, SA - 11'7/8" CP

\*Rustic Copper is a Premium color. Note: Rustic Copper (M2) accessories, including miters and end caps, may display paint finish variations due to the metallic painting process, which may affect matching components.

# Downspouts

## Downspouts

Part #	Description	Colors	Nom. Gauge/ Thickness	Piece Length	Pieces/ Box	Boxes/ Pallet
ADS238 --	Aluminum 2 x 3 x 8' DS	(Listed Below)	0.019	8'	10*	28
ADS238M2	Aluminum 2 x 3 x 8' DS	M2 (Premium Color)	0.019	8'	10*	28
ADS348 --	Aluminum 3 x 4 x 8' DS	(Listed Below)	0.019	8'	10*	15
ADS2310 --	Aluminum 2 x 3 x 10' DS	(Listed Below)	0.019	10'	10	28
ADS2310M2	Aluminum 2 x 3 x 10' DS	M2 (Premium Color)	0.019	10'	10	28
ADS3410 --	Aluminum 3 x 4 x 10' DS	(Listed Below)	0.019	10'	10	15
ADS3410M2	Aluminum 3 x 4 x 10' DS	M2 (Premium Color)	0.019	10'	10	15
ADS23410 --	Aluminum 3 x 4 x 10' DS	BK, RB, WH	0.024	10'	10	15
ADS24510 --	Aluminum 4 x 5 x 10' DS	AL, AI, BK, BZ, CC, CL, ES, FR, MB, RB, ST, TB, WH, 80, WI	0.027	10'	6	15
LDS3410	Galvalume 3 x 4 x 10' DS	Mill	26 ga	10'	10	
CDS2310	Copper 2 X 3 x 10' DS	Copper	10 oz	10'	Order by the pc.	
CDS3410	Copper 3 x 4 x 10' DS	Copper	10 oz	10'	Order by the pc.	

\*Order in full-carton quantities only.

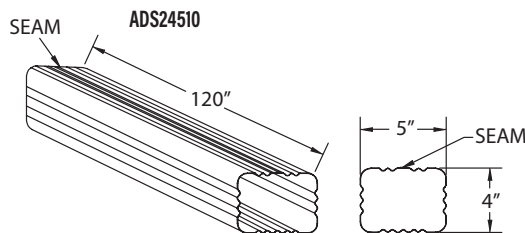
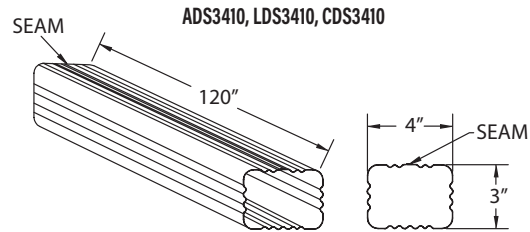
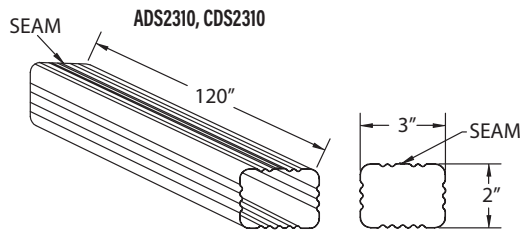

## Rainware & Accessories Colors

Color	Code	Color	Code	Color	Code	Color	Code	Color	Code	Color	Code
NX ALMOND	AD	BUCKSKIN	BU	DESERT SAND	DS	NX LINEN	LN	ROYAL BROWN	RB	TERRA BRONZE	TB
ALMOND	AL	CAMEO	CA	NX DUNE	CD	LINEN	LI	*RUSTIC COPPER	M2	VICTORIAN GREY	VG
ANTIQUE IVORY	AI	CHARCOAL GREY	CG	EGG SHELL	ES	MONTANA SUEDE	MS	SAGE	SA	WICKER	WI
BEAVER BROWN	BB	CLASSIC CREAM	CC	EVEREST	EV	MUSKET BROWN	MB	NX SAND STONE	SS	30 WHITE	WH
BLACK	BK	CLAY	CL	EVERGREEN	EG	NORWEGIAN WOOD	NW	SANDTONE	ST	80 WHITE	80
BRONZE	BZ	COPPER PENNY	CP	FROST	FR	PEBBLESTONE CLAY	PC	NX SIERRA	SI		
BROOKSTONE	BS	COUNTRY BLUE	CU	HARBOR GREY	HG	REDWOOD	RW	NX SILVER/SILVER GREY	SG		

\*Rustic Copper is a Premium color. Note: Rustic Copper (M2) accessories, including miters and end caps, may display paint finish variations due to the metallic painting process, which may affect matching components.

# Rainware

## Elbows

### Elbows

Part #	Description	Colors	Nom. Gauge/ Thickness	Piece Length	Pieces/ Box	Boxes/ Pallet
AAE23 --	Aluminum 2 x 3 A Elbow	*(Listed next page)	0.019	10 9/16"	30	32
AAE23M2	Aluminum 2 x 3 A Elbow	M2 (Premium Color)	0.019	10 9/16"	30	32
AAE34 --	Aluminum 3 x 4 A Elbow	(Listed next page)	0.019	12 3/4"	30	16
AAE34M2	Aluminum 3 x 4 A Elbow	M2 (Premium Color)	0.019	12 3/4"	30	16
AAE234 --	Aluminum 2 x 3 A Elbow	(Listed next page)	0.024	10 9/16"	30	32
AAE245 --	Aluminum 4 x 5 A Elbow	AL, AI, BK, BZ, CC, CL, ES, FR, MB, RB, ST, TB, WH, 80, WI	0.027	15 1/2"	9	12
ABE23 --	Aluminum 2 x 3 B Elbow	*(Listed next page)	0.019	11 1/2"	30	32
ABE23M2	Aluminum 2 x 3 B Elbow	M2 (Premium Color)	0.019	11 1/2"	30	32
ABE34 --	Aluminum 3 x 4 B Elbow	(Listed next page)	0.019	15"	30	16
ABE34M2	Aluminum 3 x 4 B Elbow	M2 (Premium Color)	0.019	15"	30	16
ABE234 --	Aluminum 2 x 3 B Elbow	(Listed next page)	0.024	11 1/2"	30	32
ABE245 --	Aluminum 4 x 5 B Elbow	AL, AI, BK, BZ, CC, CL, ES, FR, MB, RB, ST, TB, WH, 80, WI	0.027	15 3/4"	9	12
LAE34 --	Galvalume 3 x 4 A Elbow	Mill	26 ga	12 3/4"	30	
LBE34 --	Galvalume 3 x 4 B Elbow	Mill	26 ga	15"	30	
CAE23	Copper 2 x 3 A Elbow	Copper	10 oz	10 9/16"		Order by the pc.
CAE34	Copper 3 x 4 A Elbow	Copper	10 oz	12 3/4"		Order by the pc.
CBE23	Copper 2 x 3 B Elbow	Copper	10 oz	11 1/2"		Order by the pc.
CBE34	Copper 3 x 4 B Elbow	Copper	10 oz	15"		Order by the pc.

\*AAE23 -- & ABE23 -- not available in ES, SG.

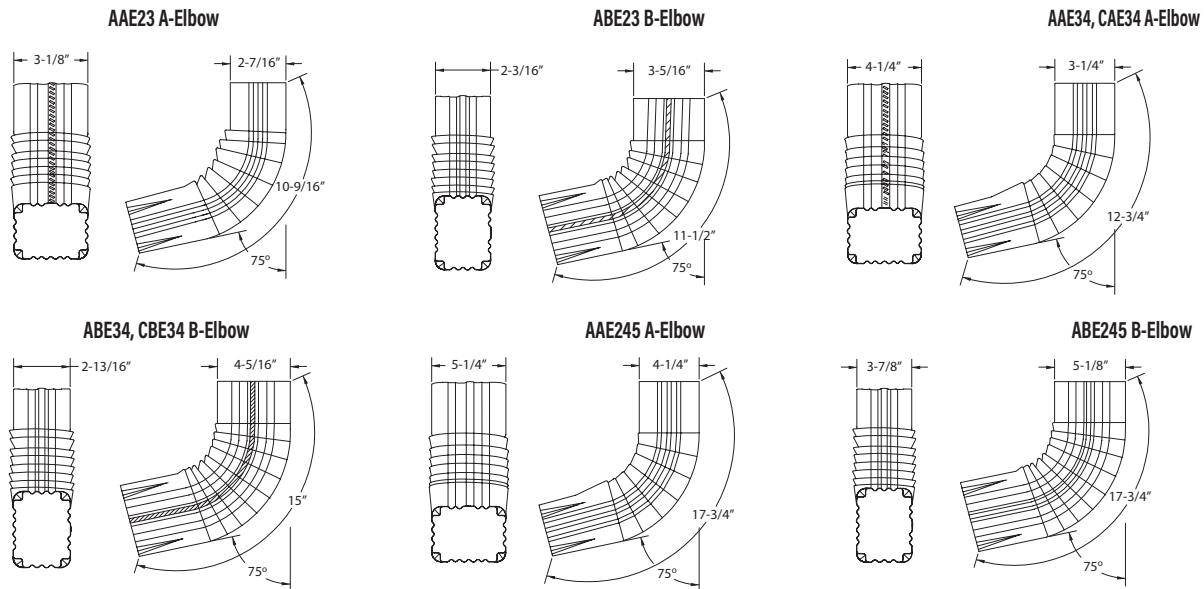

### Rainware & Accessories Colors

Color	Code	Color	Code	Color	Code	Color	Code	Color	Code	Color	Code
NX ALMOND	AD	BUCKSKIN	BU	DESERT SAND	DS	NX LINEN	LN	ROYAL BROWN	RB	TERRA BRONZE	TB
ALMOND	AL	CAMEO	CA	NX DUNE	CD	LINEN	LI	*RUSTIC COPPER	M2	VICTORIAN GREY	VG
ANTIQUE IVORY	AI	CHARCOAL GREY	CG	EGG SHELL	ES	MONTANA SUEDE	MS	SAGE	SA	WICKER	WI
BEAVER BROWN	BB	CLASSIC CREAM	CC	EVEREST	EV	MUSKET BROWN	MB	NX SAND STONE	SS	30 WHITE	WH
BLACK	BK	CLAY	CL	EVERGREEN	EG	NORWEGIAN WOOD	NW	SANDTONE	ST	80 WHITE	80
BRONZE	BZ	COPPER PENNY	CP	FROST	FR	PEBBLESTONE CLAY	PC	NX SIERRA	SI		
BROOKSTONE	BS	COUNTRY BLUE	CU	HARBOR GREY	HG	REDWOOD	RW	NX SILVER/SILVER GREY	SG		

\*Rustic Copper is a Premium color. Note: Rustic Copper (M2) accessories, including miters and end caps, may display paint finish variations due to the metallic painting process, which may affect matching components.

# Variable Degree Elbows

## Variable Degree Elbows

Part #	Description	Colors	Nom. Gauge/ Thickness	Piece Length	Pieces/ Box	Boxes/ Pallet
AAE123 --	Aluminum 2 x 3 V/D A Elbow 150	(Listed Below)	0.019	6 1/4"	30	32
AAE2223 --	Aluminum 2 x 3 V/D A Elbow 220	(Listed Below)	0.019	6 3/4"	30	16
AAE323 --	Aluminum 2 x 3 V/D A Elbow 300	(Listed Below)	0.019	(7.19)"	30	16
AAE423 --	Aluminum 2 x 3 V/D A Elbow 450	(Listed Below)	0.019	(7.94)"	30	16
AAE923 --	Aluminum 2 x 3 V/D A Elbow 900	(Listed Below)	0.019		30	--
AAE134 --	Aluminum 3 x 4 V/D A Elbow 150	(Listed Below)	0.019		30	8
AAE2234 --	Aluminum 3 x 4 V/D A Elbow 220	(Listed Below)	0.019		30	16
AAE334 --	Aluminum 3 x 4 V/D A Elbow 300	(Listed Below)	0.019		30	16
AAE434 --	Aluminum 3 x 4 V/D A Elbow 450	(Listed Below)	0.019		30	16
AAE934 --	Aluminum 3 x 4 V/D A Elbow 900	(Listed Below)	0.019		30	16
AAE3245ES	Aluminum 4 x 5 V/D A Elbow 300	ES, MB	0.027		9	12
AAE2445 --	Aluminum 4 x 5 V/D A Elbow 450	BZ, CC, ES, FR, MB, RB, ST, *TB, WH, 80	0.027		9	12
ABE123 --	Aluminum 2 x 3 V/D B Elbow 150	(Listed Below)	0.019	6 1/4"	30	16
ABE2223 --	Aluminum 2 x 3 V/D B Elbow 220	(Listed Below)	0.019	6 3/4"	30	16
ABE323 --	Aluminum 2 x 3 V/D B Elbow 300	(Listed Below)	0.019	(7.19)"	30	16
ABE423 --	Aluminum 2 x 3 V/D B Elbow 450	(Listed Below)	0.019	(7.94)"	30	16
ABE923 --	Aluminum 2 x 3 V/D B Elbow 900	(Listed Below)	0.019		30	--
ABE134 --	Aluminum 3 x 4 V/D B Elbow 150	(Listed Below)	0.019		30	8
ABE2234 --	Aluminum 3 x 4 V/D B Elbow 220	(Listed Below)	0.019		30	16
ABE334 --	Aluminum 3 x 4 V/D B Elbow 300	(Listed Below)	0.019		30	16
ABE434 --	Aluminum 3 x 4 V/D B Elbow 450	(Listed Below)	0.019		30	16
ABE934 --	Aluminum 3 x 4 V/D B Elbow 900	(Listed Below)	0.019		30	16
ABE2445 --	Aluminum 4 x 5 V/D B Elbow 450	BZ, CC, ES, FR, MB, RB, ST, *TB, WH, 80	0.027		9	12
LAE334	Galvalume 3 x 4 V/D A Elbow 300	Mill	26 ga	15"	30	
LBE334	Galvalume 3 x 4 V/D B Elbow 300	Mill	26 ga	15"	30	

\*Note: Extended lead time required for this part in this color.

This chart shows the roof pitch paired to the approximate variable degree elbow.

ROOF PITCH	DEGREE
Mansard	15°
18/12	22°
16/12	22°
14/12	22°
12/12	30°
10/12	45°
8/12	45°
6/12	45°
4/12	75°

Variable degree elbows are used to go around obstructions (ledge jumpers) or transition to the slope of the roof.

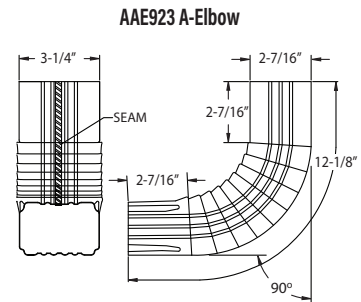
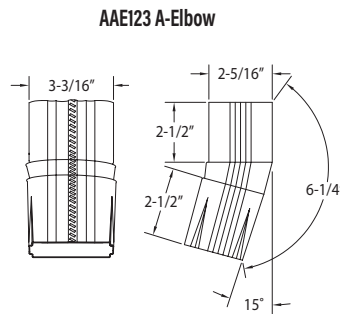

## Rainware & Accessories Colors

Color	Code	Color	Code	Color	Code	Color	Code	Color	Code	Color	Code
NX ALMOND	AD	CAMEO	CA	NX DUNE	CD	LINEN	LI	SAGE	SA	WICKER	WI
ALMOND	AL	CHARCOAL GREY	CG	EGG SHELL	ES	MONTANA SUEDE	MS	NX SAND STONE	SS	30 WHITE	WH
BEAVER BROWN	BB	CLASSIC CREAM	CC	EVEREST	EV	MUSKET BROWN	MB	SANDTONE	ST	80 WHITE	80
BLACK	BK	CLAY	CL	EVERGREEN	EG	NORWEGIAN WOOD	NW	NX SIERRA	SI		
BRONZE	BZ	COPPER PENNY	CP	FROST	FR	PEBBLESTONE CLAY	PC	NX SILVER/SILVER GREY	SG		
BROOKSTONE	BS	COUNTRY BLUE	CU	HARBOR GREY	HG	REDWOOD	RW	TERRA BRONZE	TB		
BUCKSKIN	BU	DESERT SAND	DS	NX LINEN	LN	ROYAL BROWN	RB	VICTORIAN GREY	VG		

# Rainware

## Offsets

### Offsets

Part #	Description	Colors	Nom. Gauge/ Thickness	Pieces/ Box
ABO2A23A --	Alum. Brickledge Offsets (2 pc.) 2x3 A's, 3 Crimps	*(Listed Below)	0.019	18 sets
ABO2A34A --	Alum. Brickledge Offsets (2 pc.) 3x4 A's, 3 Crimps	*(Listed Below)	0.019	18 sets
ABO1123A --	Aluminum 2 x 3 - 1" A Offset	(Listed Below)	0.019	24
ABO1223A --	Aluminum 2 x 3 - 2" A Offset	(Listed Below)	0.019	24
ABO1323A --	Aluminum 2 x 3 - 3" A Offset	(Listed Below)	0.019	24
ABO1423A --	Aluminum 2 x 3 - 4" A Offset	(Listed Below)	0.019	20
ABO1523A --	Aluminum 2 x 3 - 5" A Offset	(Listed Below)	0.019	20
ABO1623A --	Aluminum 2 x 3 - 6" A Offset	(Listed Below)	0.019	20
ABO1134A --	Aluminum 3 x 4 - 1" A Offset	(Listed Below)	0.019	24
ABO1234A --	Aluminum 3 x 4 - 2" A Offset	(Listed Below)	0.019	24
ABO1334A --	Aluminum 3 x 4 - 3" A Offset	(Listed Below)	0.019	24
ABO1434A --	Aluminum 3 x 4 - 4" A Offset	(Listed Below)	0.019	20
ABO1534A --	Aluminum 3 x 4 - 5" A Offset	(Listed Below)	0.019	20
ABO1634A --	Aluminum 3 x 4 - 6" A Offset	(Listed Below)	0.019	20
LBO1234A	Galvalume 3 x 4 - 2" A Offset	Mill	28 ga	24
LBO1534A	Galvalume 3 x 4 - 5" A Offset	Mill	28 ga	20
ABO1145A --	Aluminum 4 x 5 - 1" A's	AL, AI, BK, BZ, CC, CL, ES, FR, MB, RB, ST, TB, WH, 80, WI	0.027	9
ABO1245A --	Aluminum 4 x 5 - 2" A's	AL, AI, BK, BZ, CC, CL, ES, FR, MB, RB, ST, TB, WH, 80, WI	0.027	9
ABO1345A --	Aluminum 4 x 5 - 3" A's	AL, AI, BK, BZ, CC, CL, ES, FR, MB, RB, ST, TB, WH, 80, WI	0.027	9
ABO1445A --	Aluminum 4 x 5 - 4" A's	AL, AI, BK, BZ, CC, CL, ES, FR, MB, RB, ST, TB, WH, 80, WI	0.027	9
ABO1545A --	Aluminum 4 x 5 - 5" A's	AL, AI, BK, BZ, CC, CL, ES, FR, MB, RB, ST, TB, WH, 80, WI	0.027	9
ABO1645A --	Aluminum 4 x 5 - 6" A's	AL, AI, BK, BZ, CC, CL, ES, FR, MB, RB, ST, TB, WH, 80, WI	0.027	9

All "A" Offsets also available in "B" profiles. **\*Note:** ABO2A34A not available in SI.

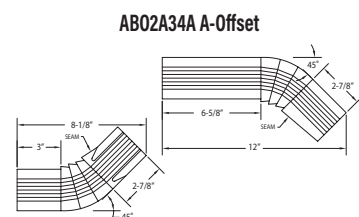
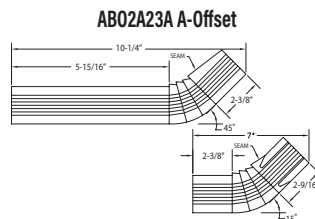
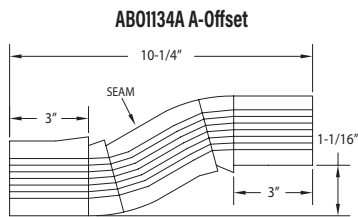
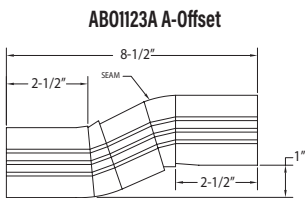

### Rainware & Accessories Colors

Color	Code	Color	Code	Color	Code	Color	Code	Color	Code	Color	Code
NX ALMOND	AD	BUCKSKIN	BU	DESERT SAND	DS	NX LINEN	LN	ROYAL BROWN	RB	VICTORIAN GREY	VG
ALMOND	AL	CAMEO	CA	NX DUNE	CD	LINEN	LI	SAGE	SA	WICKER	WI
ANTIQUE IVORY	AI	CHARCOAL GREY	CG	EGG SHELL	ES	MONTANA SUEDE	MS	NX SAND STONE	SS	30 WHITE	WH
BEAVER BROWN	BB	CLASSIC CREAM	CC	EVEREST	EV	MUSKET BROWN	MB	SANDTONE	ST	80 WHITE	80
BLACK	BK	CLAY	CL	EVERGREEN	EG	NORWEGIAN WOOD	NW	NX SIERRA	SI		
BRONZE	BZ	COPPER PENNY	CP	FROST	FR	PEBBLESTONE CLAY	PC	NX SILVER/SILVER GREY	SG		
BROOKSTONE	BS	COUNTRY BLUE	CJ	HARBOR GREY	HG	REDWOOD	RW	TERRA BRONZE	TB		

**\*Rustic Copper is a Premium color. Note:** Rustic Copper (M2) accessories, including miters and end caps, may display paint finish variations due to the metallic painting process, which may affect matching components.

# Downspout Accessories

## Outlets

Part #	Description	Colors	Nom. Gauge/ Thickness	Pieces/ Box
AORE23ML	Aluminum 2 x 3 Rectangle Outlet	*		30
AORE34ML	Aluminum 3 x 4 Rectangle Outlet	*		50
AORE45ML	Aluminum 4 x 5 Rectangle Outlet	*		50
AOR0238ML	Aluminum 2 3/8" Round Outlet	*		250
AOR0234ML	Aluminum 2 3/4" Round Outlet	*		250
AOR0338ML	Aluminum 3 3/8" Round Outlet	*		100
AOOV23ML	Aluminum 2 x 3 Oval Outlet	*		30
AOOV34ML	Aluminum 3 x 4 Oval Outlet	*		50
CORE34	Copper 3 x 4 Rectangle Outlet	Copper	16 oz	Order by the pc.

\*Aluminum outlets made with mill or painted finish per manufacturer's discretion.

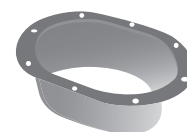

Oval Outlet

## PVC Adapters

Part #	Description	Colors	Pieces/ Box
APVC234WH	PVC 2 x 3 x 4 Flush Mount Adapter	WH	12
APVC234BK	PVC 2 x 3 x 4 Flush Mount Adapter	BK	12
APVC344WH	PVC 3 x 4 x 4 Flush Mount Adapter	WH	12
APVC344BK	PVC 3 x 4 x 4 Flush Mount Adapter	BK	12



## Y Adapters

Part #	Description	Colors	Nom. Gauge/ Thickness	Pieces/ Box
AYA34WH	Aluminum 3 x 4 "Y" Adapter	WH	0.019	10



## Downspout Bands

Part #	Description	Colors	Nom. Gauge/ Thickness	Pieces/ Box
ADSPB34 - -	Aluminum 3 x 4 Universal DS Band	(Listed Below)	0.019	100



# Rainware

## Downspout Clips

Part #	Description	Colors	Nom. Gauge/ Thickness	Pieces/ Box
ADSCP23 --	Aluminum 2 x 3 DS Clip	WH	0.032	100
ADSCP34 --	Aluminum 3 x 4 DS Clip	WH	0.032	50
ADSCP34M2	Aluminum 3 x 4 DS Clip	M2 (Premium Color)	0.032	50

*Note: Rustic Copper (M2) accessories, including miters and end caps, may display paint finish variations due to the metallic painting process, which may affect matching components.*



## Downspout Hinges

Part #	Description	Colors	Pairs/ Bags
AZHWH	Aluminum 2 x 3 / 3 x 4 Zip Hinge	WH	12 pairs



## Splash Blocks

Part #	Description	Colors	Pieces/ Box
SBGN	Splash Block - Green	GN	Order by the pc. 10 pcs./box

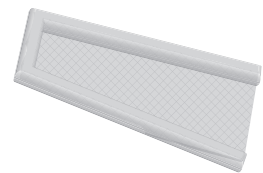

## Miters

### Box Miters

Part #	Description	Colors	Nom. Gauge/ Thickness	Pieces/ Box
ABM5I --	Aluminum 5" Inside Miter	(Listed Below)	0.019	20
ABM5O --	Aluminum 5" Outside Miter	(Listed Below)	0.019	20
ABM5IM2	Aluminum 5" Inside Miter	M2 (Premium Color)	0.019	20
ABM5OM2	Aluminum 5" Outside Miter	M2 (Premium Color)	0.019	20
ABM6I --	Aluminum 6" Inside Miter	(Listed Below)	0.019	20
ABM6O --	Aluminum 6" Outside Miter	(Listed Below)	0.019	20
ABM6IM2	Aluminum 6" Inside Miter	M2 (Premium Color)	0.019	20
ABM6OM2	Aluminum 6" Outside Miter	M2 (Premium Color)	0.019	20
LBM6I	Galvalume 6" Inside	Mill	26 ga	20
LBM6O	Galvalume 6" Outside	Mill	26 ga	20

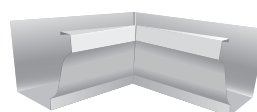

Box Miter Inside

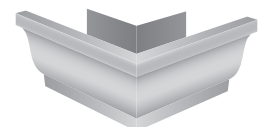

Box Miter Outside

## Bay Miters

Part #	Description	Colors Nom. Gauge/	Pieces/ Thickness	Box
ABY51 --	Aluminum 5" Inside Bay Miter	(Listed Below)	0.019	20
ABY50 --	Aluminum 5" Outside Bay Miter	(Listed Below)	0.019	20
ABY51M2	Aluminum 5" Inside Bay Miter	M2 (Premium Color)	0.019	20
ABY50M2	Aluminum 5" Outside Bay Miter	M2 (Premium Color)	0.019	20
ABY61 --	Aluminum 6" Inside Bay Miter	(Listed Below)	0.019	20
ABY60 --	Aluminum 6" Outside Bay Miter	(Listed Below)	0.019	20
ABY61M2	Aluminum 6" Inside Bay Miter	M2 (Premium Color)	0.019	20
ABY60M2	Aluminum 6" Outside Bay Miter	M2 (Premium Color)	0.019	20
ABY71 --	Aluminum 7" Inside Bay Miter	BZ, ES, FR, RB, ST, WH, 80	0.019	20
ABY70 --	Aluminum 7" Outside Bay Miter	BZ, ES, FR, RB, ST, WH, 80	0.019	20
LBY61	Galvalume 6" Inside Bay Miter	Mill	26 ga	20
LBY60	Galvalume 6" Outside Bay Miter	Mill	26 ga	20
CBY61	Copper 6" Inside Bay Miter	Copper 16 oz	By the pc.	
CBY60	Copper 6" Outside Bay Miter	Copper 16 oz	By the pc.	



Bay Miters  
450 Outside

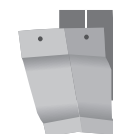

Bay Miters  
450 Inside

## Strip Miters

Part #	Description	Colors Nom. Gauge/	Pieces/ Thickness	Box
ASM51 --	Aluminum 5" Inside Strip Miter	(Listed Below)	0.027	20
ASM50 --	Aluminum 5" Outside Strip Miter	(Listed Below)	0.027	20
ASM51M2	Aluminum 5" Inside Strip Miter	M2 (Premium Color)	0.027	20
ASM50M2	Aluminum 5" Outside Strip Miter	M2 (Premium Color)	0.027	20
ASM61 --	Alum. 6" Inside Strip Miter	(Listed Below)	0.027	20
ASM60 --	Alum. 6" Outside Strip Miter	(Listed Below)	0.027	20
ASM61M2	Alum. 6" Inside Strip Miter	M2 (Premium Color)	0.027	20
ASM60M2	Alum. 6" Outside Strip Miter	M2 (Premium Color)	0.027	20
ASM71 --	Aluminum 7" Inside Strip Miter	BZ, ES, FR, RB, ST, WH, 80	0.027	20
ASM70 --	Aluminum 7" Outside Strip Miter	BZ, ES, FR, RB, ST, WH, 80	0.027	20
LSM51	Galvalume 5" Inside Strip Miter	Mill	26 ga	20
LSM50	Galvalume 5" Outside Strip Miter	Mill	26 ga	20
LSM61	Galvalume 6" Inside Strip Miter	Mill	26 ga	20
LSM60	Galvalume 6" Outside Strip Miter	Mill	26 ga	20
CSM61	Copper 6" Inside Strip Miter	Copper 16 oz	By the pc.	
CSM60	Copper 6" Outside Strip Miter	Copper 16 oz	By the pc.	



Strip Miters  
900 Inside



Strip Miters  
900 Outside

## Extreme Miters

Part #	Description	Colors Nom. Gauge/	Pieces/ Thickness	Box
AEM5 --	Aluminum 5" Extreme Miter™	RB, WH, 80	0.019	10



## Rainware & Accessories Colors

Color	Code	Color	Code	Color	Code	Color	Code	Color	Code	Color	Code
NX ALMOND	AD	BUCKSKIN	BU	DESERT SAND	DS	NX LINEN	LN	ROYAL BROWN	RB	TERRA BRONZE	TB
ALMOND	AL	CAMEO	CA	NX DUNE	CD	LINEN	LI	*RUSTIC COPPER	M2	VICTORIAN GREY	VG
ANTIQUE IVORY	AI	CHARCOAL GREY	CG	EGG SHELL	ES	MONTANA SUEDE	MS	SAGE	SA	WICKER	WI
BEAVER BROWN	BB	CLASSIC CREAM	CC	EVEREST	EV	MUSKET BROWN	MB	NX SAND STONE	SS	30 WHITE	WH
BLACK	BK	CLAY	CL	EVERGREEN	EG	NORWEGIAN WOOD	NW	SANDTONE	ST	80 WHITE	80
BRONZE	BZ	COPPER PENNY	CP	FROST	FR	PEBBLESTONE CLAY	PC	NX SIERRA	SI		
BROOKSTONE	BS	COUNTRY BLUE	CU	HARBOR GREY	HG	REDWOOD	RW	NX SILVER/SILVER GREY	SG		

\*Rustic Copper is a Premium color. Note: Rustic Copper (M2) accessories, including miters and end caps, may display paint finish variations due to the metallic painting process, which may affect matching components.

# Rainware

## Expansion Joints & End Caps

### Expansion Joints

Part #	Description	Colors	Nom. Gauge/ Thickness	Pieces/ Box
AEJ5ML	Aluminum 5" Expansion Joint	Mill	0.030	12
AEJ6ML	Aluminum 6" Expansion Joint	Mill	0.030	12

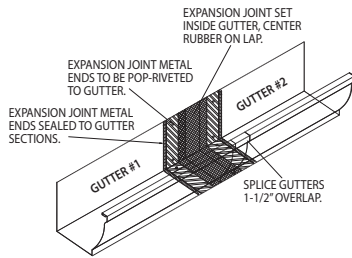

A 40' section of gutter can potentially expand almost 2/3 of an inch from winter to summer moving the fasteners back and forth until the gutter falls down. Expansion joints are a preventive measure for excessive movement in the gutter, and should be mounted in place every 40' of exceptionally long gutter runs.

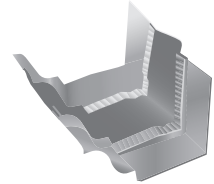

### End Caps

Part #	Description	Colors	Nom. Gauge/ Thickness	Piece Length	Pieces/ Box
AEC5L --	Aluminum 5" Left End Cap	(Listed Below)	0.019	5"	50
AEC5R --	Aluminum 5" Right End Cap	(Listed Below)	0.019	5"	50
AEC5LM2	Aluminum 5" Left End Cap	M2 (Premium Color)	0.019	5"	50
AEC5RM2	Aluminum 5" Right End Cap	M2 (Premium Color)	0.019	5"	50
AEC6L --	Aluminum 6" Left End Cap	(Listed Below)	0.019	6"	50
AEC6R --	Aluminum 6" Right End Cap	(Listed Below)	0.019	6"	50
AEC6LM2	Aluminum 6" Left End Cap	M2 (Premium Color)	0.019	6"	50
AEC6RM2	Aluminum 6" Right End Cap	M2 (Premium Color)	0.019	6"	50
AEC7L --	Aluminum 7" Left End Cap	BZ, ES, FR, RB, ST, WH, 80	0.027	7"	50
AEC7R --	Aluminum 7" Right End Cap	BZ, ES, FR, RB, ST, WH, 80	0.027	7"	50
LEC5L	Galvalume 5" Left End Cap	Mill	26 ga	5"	50
LEC5R	Galvalume 5" Right End Cap	Mill	26 ga	5"	50
LEC6L	Galvalume 6" Left End Cap	Mill	26 ga	6"	50
LEC6R	Galvalume 6" Right End Cap	Mill	26 ga	6"	50
CEC5L	Copper 5" Left End Cap	Copper	16 oz	5"	By the pc.
CEC5R	Copper 5" Right End Cap	Copper	16 oz	5"	By the pc.
CEC6L	Copper 6" Left End Cap	Copper	16 oz	6"	By the pc.
CEC6R	Copper 6" Right End Cap	Copper	16 oz	6"	By the pc.

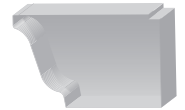

Right End Cap



Left End Cap

### Rainware & Accessories Colors

Color	Code	Color	Code	Color	Code	Color	Code	Color	Code	Color	Code
NX ALMOND	AD	BUCKSKIN	BU	DESERT SAND	DS	NX LINEN	LN	ROYAL BROWN	RB	TERRA BRONZE	TB
ALMOND	AL	CAMEO	CA	NX DUNE	CD	LINEN	LI	*RUSTIC COPPER	M2	VICTORIAN GREY	VG
ANTIQUE IVORY	AI	CHARCOAL GREY	CG	EGG SHELL	ES	MONTANA SUEDE	MS	SAGE	SA	WICKER	WI
BEAVER BROWN	BB	CLASSIC CREAM	CC	EVEREST	EV	MUSKET BROWN	MB	NX SAND STONE	SS	30 WHITE	WH
BLACK	BK	CLAY	CL	EVERGREEN	EG	NORWEGIAN WOOD	NW	SANDTONE	ST	80 WHITE	80
BRONZE	BZ	COPPER PENNY	CP	FROST	FR	PEBBLESTONE CLAY	PC	NX SIERRA	SI		
BROOKSTONE	BS	COUNTRY BLUE	CJ	HARBOR GREY	HG	REDWOOD	RW	NX SILVER/SILVER GREY	SG		

\*Rustic Copper is a Premium color. Note: Rustic Copper (M2) accessories, including miters and end caps, may display paint finish variations due to the metallic painting process, which may affect matching components.

# Hangers

## Hidden Hangers

Part #	Description	Colors	Nom. Gauge/ Thickness	Pieces/ LengthBox	Pieces/ LengthBox
AHH5ML	Aluminum 5" Hook Hanger with Clip	Mill	0.060	4 7/8"	500
AHH51ML	Aluminum 5" Hook Hanger with Clip	Mill	0.060	4 7/8"	100
AHT5CML	Aluminum 5" Hangtite Hanger with Clip	Mill	0.060	5"	1000
AHHWF5ML	Aluminum 5" Flanged Hanger with Clip	Mill	0.060	5"	500
AHH5NHML	Aluminum 5" Hook Hanger without Hole	Mill	0.060	5"	500
ABH5ML	Aluminum 5" Backless Std. Bar Hanger	Mill	0.060	5 1/16"	400
AHU51ML	Aluminum 5" Ultra Hanger without Clip	Mill	0.048	5"	100
AHU5ML	Aluminum 5" Ultra Hanger without Clip	Mill	0.048	5"	1000
AHU51CML	Aluminum 5" Ultra Hanger with Clip	Mill	0.048	5"	100
AHU5CML	Aluminum 5" Ultra Hanger with Clip	Mill	0.048	5"	1000
AHH6ML	Aluminum 6" Hook Hanger with Clip	Mill	0.060	6"	250
AHHK6ML	Aluminum 6" Keg Hanger with Clip	Mill	0.060	6"	2500
AHT6CML	Aluminum 6" Hangtite Hanger with Clip	Mill	0.060	6"	1000
AHHWF6ML	Aluminum 6" Flanged Hanger with Clip	Mill	0.060	6"	250
ABH6ML	Aluminum 6" Backless Std. Bar Hanger	Mill	0.060	6 1/16"	750
AHU61ML	Aluminum 6" Ultra Hanger without Clip	Mill	0.048	6"	100
AHU6ML	Aluminum 6" Ultra Hanger without Clip	Mill	0.048	6"	1000
AHU61CML	Aluminum 6" Ultra Hanger with Clip	Mill	0.048	6"	100
AHU6CML	Aluminum 6" Ultra Hanger with Clip	Mill	0.048	6"	800
BH6	Brass 6" Hanger with Clip	Brass	0.115	6 3/16"	150
3040000	5" Hidden Hanger No Screw				
3062000	6" Hidden Hanger No Screw				
3040001	5" Hidden Hanger with Screw				
3062001	6" Hidden Hanger with Screw				
3062060	6" - 1/2" RUD Hidden Hanger				
3062101	6" Hidden Hanger Copper				
3062108	5" Hidden Hanger Supreme				
3062110	6" Hidden Hanger Supreme				

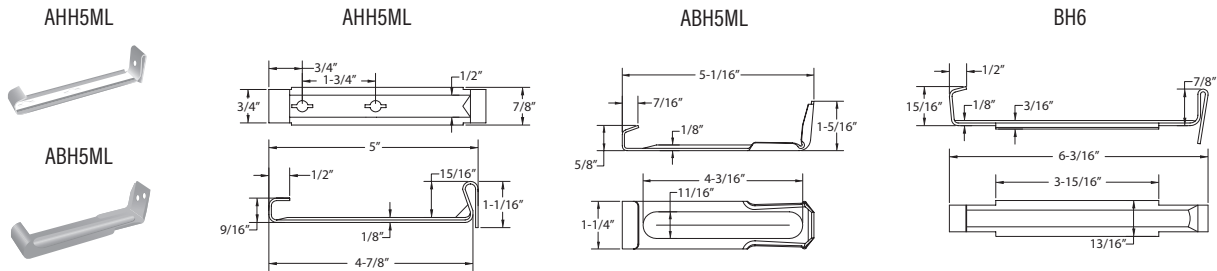

## Wrap Around

Part #	Description	Colors	Nom. Gauge/ Thickness	Pieces/ LengthBox	Pieces/ LengthBox
AWAH5 - -	Aluminum 5" Wrap Around Hanger	RB, WH, 80	0.060	16-3/4" 100	
AWAH6 - -	Aluminum 6" Wrap Around Hanger	WH	0.060	20-1/4" 50	

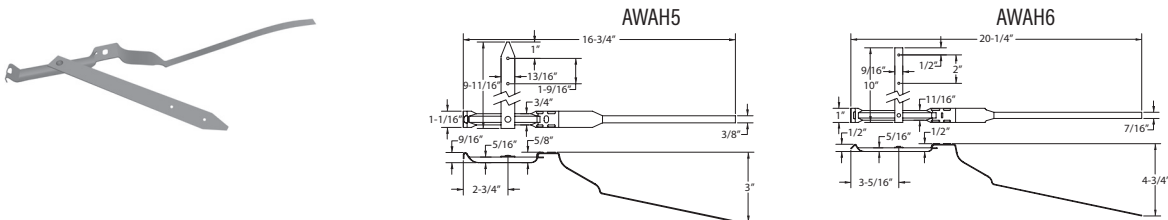

# Rainware

## T-Bar

Part #	Description	Colors	Nom. Gauge/ Thickness	Pieces/ LengthBox	Pieces/ LengthBox
ATBH5ML	Aluminum 5" T-Bar Strap Hanger w/Clip	Mill	0.060	12 1/2"	100
ATS5ML	Aluminum 5/8" T-Bar Strap only	Mill	0.032	9 7/8"	100



ATBH5

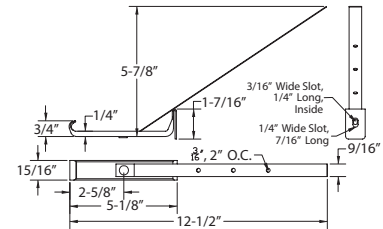

## Hangers with Screws

Part #	Description	Colors	Nom. Gauge/ Thickness	Pieces/ LengthBox	Pieces/ LengthBox
AHFHS5ML	Alum. 5" Quick Screw Hidden Hgr w/Screw	Mill	0.060	5"	500
AHFHS6ML	Alum. 6" Quick Screw Hidden Hgr w/Screw	Mill	0.060	6"	300
AHUTS5CML	Alum. 5" Ultimate Hidden Hanger w/Screw & Clip	Mill	0.061	5"	400
AHUTS6CML	Alum. 6" Ultimate Hidden Hanger w/Screw & Clip	Mill	0.061	6"	300
AHFHS7ML	Alum. 7" Quick Screw Hidden Hgr w/Screw	Mill	0.060	7"	100
BHFHS5	Brass 5" Hang Fast w/Screw	Brass	0.115	5"	Order by the pc.

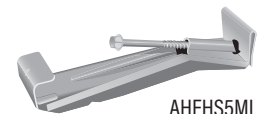

AHFHS5ML

## Rainware Accessories

### T-Wedge

Part #	Description	Colors	Nom. Gauge/ Thickness	Pieces/ Bag
ATW44ML	Aluminum 5" T-Wedge 4400	Mill	0.070	50
ATW45MML	Aluminum 6" T-Wedge 4500	Mill	0.070	50
ATWHR49ML	Aluminum 6" Half Round T-Wedge 4900	Mill	0.070	50

A T-Wedge can be adjusted to keep the gutter level at various fascia board angles.

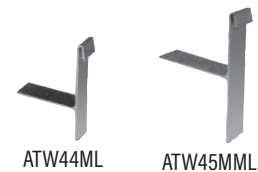

ATW44ML

ATW45MML

### Gutter Wedges

Part #	Description	Colors	Nom. Gauge/ Thickness	Pieces/ Box
GW5 - -	Aluminum 5" Gutter Wedge	RB, WH	0.027	100
GW6 - -	Aluminum 6" Gutter Wedge	RB, WH	0.027	50



GW5, GW6

## Spikes

Part #	Description	Colors	Nom. Gauge/ Thickness	Pieces/ Box
AS7WH	Aluminum 7" Painted Spike	WH	7"	500
AS8WH	Aluminum 8" Painted Spike	WH	8"	500
AS8ML	Aluminum 8" Spike	Mill	8"	500



## Ferrules

Part #	Description	Colors	Nom. Gauge/ Thickness	Pieces/ Box
AF5ML	Aluminum 5" Ferrule	Mill	5"	500
AF6ML	Aluminum 6" Ferrule	Mill	6"	500



# Round Products

## Round Downspouts

Part #	Description	Colors	Nom. Gauge/ Thickness	Piece Length	Pieces/ Box	Boxes/ Pallet
ADSR310 - -	Alum. 3" Round x 10', Smooth	(Listed Below)	0.019	10'	5	30
ADSR310M2	Alum. 3" Round x 10', Smooth	M2 (Premium Color)	0.019	10'	5	30
ADSR410 - -	Alum. 4" Round x 10', Smooth	(Listed Below)	0.019	10'	5	20
ADSR410M2	Alum. 4" Round x 10', Smooth	M2 (Premium Color)	0.019	10'	5	20
GDSR410 - -	Galv. 4" Round x 10'	(Listed Below)	26 ga	10'	5	30
GDSR410ML	Galv. 4" Round x 10'	Mill	26 ga	10'	5	30
LDSR310	Glum. 3" Round x 10', Plain	Mill	26 ga	10'	5	28
LDSR410	Glum. 4" Round x 10', Plain	Mill	26 ga	10'	5	28
CDSR310	Copper 3" Round x 10', Smooth	Copper	10 oz	10'	By the pc.	
CDSR410	Copper 4" Round x 10', Smooth	Copper	10 oz	10'	By the pc.	

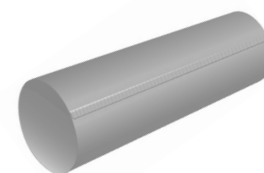

## Rainware & Accessories Colors

Color	Code	Color	Code	Color	Code	Color	Code	Color	Code	Color	Code
ALMOND	AL	■ BRONZE	BZ	CLASSIC CREAM CLAY	CC	■ MUSKET BROWN	MB	* ■ RUSTIC COPPER	M2	WICKER	WI
ANTIQUE IVORY	AI	BUCKSKIN	BU	CLAY	CL	PEBBLESTONE CLAY	PC	SANDTONE	ST	■ 30 WHITE	WH
BEAVER BROWN	BB	CAMEO	CA	■ COPPER PENNY	CP	*PG METALLIC	M3	TERRA BRONZE	TB	80 WHITE	80
BLACK	BK	CHARCOAL GREY	CG	HARBOR GREY	HG	ROYAL BROWN	RB	VICTORIAN GREY	VG		

\*Rustic Copper and PG Metallic is a Premium color. ■ Stocked half-round colors. Balance of colors available with extended lead-time.

# Rainware

## Round Elbows

Part #	Description	Colors	Nom. Gauge/ Thickness	Pieces/ Box	Boxes/ Pallet
AER3 - -	Alum. 3" Round 750	(Listed Below)	0.019	30	16
AER3M2	Alum. 3" Round 750	M2 (Premium Color)	0.019	30	16
AER4 - -	Alum. 4" Round 750	(Listed Below)	0.019	30	16
AER4M2	Alum. 4" Round 750	M2 (Premium Color)	0.019	30	16
GER430ML	Galv. 4" Round 300	Mill	26 ga	20	24
GER445 - -	Galv. 4" Round 450	(Listed Below)	26 ga	20	24
GER445ML	Galv. 4" Round 450	Mill	26 ga	20	24
GER475 - -	Galv. 4" Round 750	(Listed Below)	26 ga	20	24
GER475ML	Galv. 4" Round 750	Mill	26 ga	20	24
LER3	Glum. 3" Round 750	Mill	26 ga	10	32
LER445	Glum. 4" Round 450	Mill	26 ga	10	32
LER4	Glum. 4" Round 750	Mill	26 ga	10	32
CER330	Copper 3" Round 300	Copper	10 oz	By the pc.	
CER3	Copper 3" Round 750	Copper	10 oz	By the pc.	
CER430	Copper 4" Round 300	Copper	10 oz	By the pc.	
CER4	Copper 4" Round 750	Copper	10 oz	By the pc.	

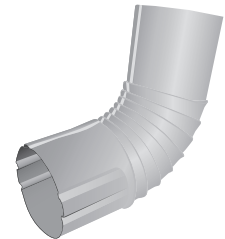

## Round Offsets

Part #	Description	Colors	Nom. Gauge/ Thickness	Pieces/ Box
ABO12R3 - -	Aluminum 2" Offset 3" Round	(Listed Below)	0.019	20
ABO12R3M2	Aluminum 2" Offset 3" Round	M2 (Premium Color)	0.019	20
ABO14R3 - -	Aluminum 4" Offset 3" Round	(Listed Below)	0.019	20
ABO14R3M2	Aluminum 4" Offset 3" Round	M2 (Premium Color)	0.019	20
ABO12R4 - -	Aluminum 2" Offset 4" Round	(Listed Below)	0.019	20
ABO12R4M2	Aluminum 2" Offset 4" Round	M2 (Premium Color)	0.019	20
ABO14R4 - -	Aluminum 4" Offset 4" Round	(Listed Below)	0.019	20
ABO14R4M2	Aluminum 4" Offset 4" Round	M2 (Premium Color)	0.019	20
ABO16R4 - -	Aluminum 6" Offset 4" Round	(Listed Below)	0.019	20

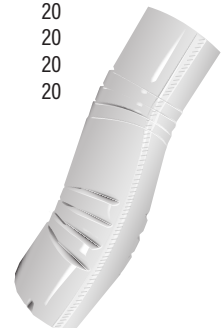

## Rainware & Accessories Colors

Color	Code	Color	Code	Color	Code	Color	Code	Color	Code	Color	Code
ALMOND	AL	■ BRONZE	BZ	CLASSIC CREAM	CC	■ MUSKET BROWN	MB	* ■ RUSTIC COPPER	M2	WICKER	WI
ANTIQUÉ IVORY	AI	BUCKSKIN	BU	CLAY	CL	PEBBLESTONE CLAY	PC	SANDTONE	ST	■ 30 WHITE	WH
BEAVER BROWN	BB	CAMEO	CA	■ COPPER PENNY	CP	*PG METALLIC	M3	TERRA BRONZE	TB	80 WHITE	80
BLACK	BK	CHARCOAL GREY	CG	HARBOR GREY	HG	ROYAL BROWN	RB	VICTORIAN GREY	VG		

\*Rustic Copper and PG Metallic is a Premium color. ■ Stocked half-round colors. Balance of colors available with extended lead-time.

# Half Round Products

## Half Round Gutters

Part #	Description	Colors	Nom. Gauge/ Thickness	Piece Length	Pieces/ Box	Boxes/ Pallet
AGUH610 --	Alum. 6" Reverse Bead 10' Sections	(Listed Below)	0.027	10'	5	16
AGUH610M2	Alum. 6" Reverse Bead 10' Sections	M2 (Premium Color)	0.027	10'	5	16
AGUH620 --	Alum. 6" Reverse Bead 20' Sections	(Listed Below)	0.027	20'	5	16
AGUH620M2	Alum. 6" Reverse Bead 20' Sections	M2 (Premium Color)	0.027	20'	5	16
LGUH610	Glum. 6" Reverse Bead 10' Sections	Mill	26 ga	10'	5	16
LGUH620	Glum. 6" Reverse Bead 20' Sections	Mill	26 ga	20'	5	16
CGUH610	Copper 6" Reverse Bead 10' Sections	Copper	10 oz	10'	5	
CGUH620	Copper 6" Reverse Bead 20' Sections	Copper	10 oz	20'	5	

Sold in 5-count cartons only.



## Half Round Outlets

Part #	Description	Colors	Nom. Gauge/ Thickness	Pieces/ Box
AOROH63ML	Aluminum 3" Round x 6" HR Outlet	*	0.019	50
AOROH64ML	Aluminum 4" Round x 6" HR Outlet	*	0.019	50
GOROH63	Galvanized 3" Round x 6" HR Outlet	*	26 ga	Order by the pc.
GOROH64	Galvanized 4" Round x 6" HR Outlet	*	26 ga	Order by the pc.
COROH63	Copper 3" Round x 6" HR Outlet	Copper	10 oz	Order by the pc.
COROH64	Copper 4" Round x 6" HR Outlet	Copper	10 oz	Order by the pc.

\*Note: Aluminum outlets made with mill or painted finish per manufacturer's discretion.



## Half Round Miters

Part #	Description	Colors	Nom. Gauge/ Thickness	Pieces/ Box
ASMH61 --	Aluminum 6" 90°, Strip, Inside	(Listed Below)	0.027	20
ASMH61M2	Aluminum 6" 90°, Strip, Inside	M2 (Premium Color)	0.027	20
ASMH60 --	Aluminum 6" 90°, Strip, Outside	(Listed Below)	0.027	20
ASMH60M2	Aluminum 6" 90°, Strip, Outside	M2 (Premium Color)	0.027	20
ABYH61 --	Aluminum 6" 45°, Bay, Inside	(Listed Below)	0.027	20
ABYH61M2	Aluminum 6" 45°, Bay, Inside	M2 (Premium Color)	0.027	20
ABYH60 --	Aluminum 6" 45°, Bay, Outside	(Listed Below)	0.027	20
ABYH60M2	Aluminum 6" 45°, Bay, Outside	M2 (Premium Color)	0.027	20
LSMH61	Galvalume 6" 90°, Strip, Inside	Mill	26 ga	20
LSMH60	Galvalume 6" 90°, Strip, Outside	Mill	26 ga	20
CSMH61	Copper 6" 90°, Strip, Inside	Copper	10 oz	20
CSMH60	Copper 6" 90°, Strip, Outside	Copper	10 oz	20



ASMH60

ASMH61

ABYH60

ABYH61

## Rainware & Accessories Colors

Color	Code	Color	Code	Color	Code	Color	Code	Color	Code	Color	Code
ALMOND	AL	■ BRONZE	BZ	CLASSIC CREAM	CC	■ MUSKET BROWN	MB	* ■ RUSTIC COPPER	M2	WICKER	WI
ANTIQUE IVORY	AI	BUCKSKIN	BU	CLAY	CL	PEBBLESTONE CLAY	PC	SANDTONE	ST	■ 30 WHITE	WH
BEAVER BROWN	BB	CAMEO	CA	■ COPPER PENNY	CP	*PG METALLIC	M3	TERRA BRONZE	TB	80 WHITE	80
BLACK	BK	CHARCOAL GREY	CG	HARBOR GREY	HG	ROYAL BROWN	RB	VICTORIAN GREY	VG		

\*Rustic Copper and PG Metallic is a Premium color. ■ Stocked half-round colors. Balance of colors available with extended lead-time.

# Rainware

## Half Round Slip Joints

Part #	Description	Colors	Nom. Gauge/ Thickness	Pieces/ Box
ASJCH6WH	Aluminum 6" HR Slip Joint	WH	0.019	Order by the pc.
LSJCH6WH	Galvalume 6" HR Slip Joint	WH	26 ga	Order by the pc.



## Half Round End Caps

Part #	Description	Colors	Nom. Gauge/ Thickness	Pieces/ Box
AECH6 - -	Aluminum 6" HR Universal End Cap	(Listed Below)	0.019	20
AECH6M2	Aluminum 6" HR Universal End Cap	M2 (Premium Color)	0.019	20
LECH6	Galvalume 6" HR Universal End Cap	Mill	26 ga	20
CECH6	Copper 6" HR Universal End Cap	Mill	26 ga	20

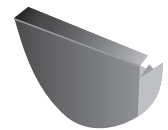

## Half Round Brackets

Part #	Description	Colors	Pieces/ Box
ACC10H6 - -	Aluminum 6" HR Combo Cir/Shk w/Clip Hanger	BZ, MB, WH, 80	50
ACC10H6ML	Aluminum 6" HR Combo Cir/Shk w/Clip Hanger	Mill	Order by the pc.
AHRFH6 - -	Aluminum 6" HR Fascia Hanger	BZ, MB, WH	Order by the pc.
GCC10H6	Galvanized 6" HR Combo Cir/Shk w/Clip Hanger	Mill	Order by the pc.
LHRFH6	Galvalume 6" HR Fascia Hanger	Mill	Order by the pc.
CCC10H6	Copper 6" HR Combo Cir/Shk w/Clip Hanger	Copper	Order by the pc.
CHRFH6	Copper 6" HR Fascia Hanger	Copper	Order by the pc.



ACC10H6



AHRFH6

## Half Round Brackets

Part #	Description	Colors	Pieces/ Box
AHHHR6ML	Aluminum 6" HR Hook Hanger	Mill	100
AHSHR6ML	Aluminum 6" HR Hidden Clip Hanger w/Screw	Mill	100
SHHHR6ML	Stainless Steel 6" HR Hook Hanger	Mill	100

Note: Only for reverse bead half round gutters

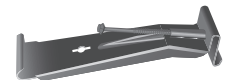

## Rainware & Accessories Colors

Color	Code	Color	Code	Color	Code	Color	Code	Color	Code	Color	Code
ALMOND	AL	■ BRONZE	BZ	CLASSIC CREAM	CC	■ MUSKET BROWN	MB	* ■ RUSTIC COPPER	M2	WICKER	WI
ANTIQUÉ IVORY	AI	BUCKSKIN	BU	CLAY	CL	PEBBLESTONE CLAY	PC	SANDTONE	ST	■ 30 WHITE	WH
BEAVER BROWN	BB	CAMEO	CA	■ COPPER PENNY	CP	*PG METALLIC	M3	TERRA BRONZE	TB	80 WHITE	80
BLACK	BK	CHARCOAL GREY	CG	HARBOR GREY	HG	ROYAL BROWN	RB	VICTORIAN GREY	VG		

\*Rustic Copper and PG Metallic is a Premium color. ■ Stocked half-round colors. Balance of colors available with extended lead-time.

## Half Round T-Wedge Hangers

Part #	Description	Colors	Nom. Gauge/ Thickness	Pieces/ Box
--------	-------------	--------	--------------------------	----------------

ATWHR49ML	Aluminum HR T-Wedge 4900	Mill	0.070	50
-----------	--------------------------	------	-------	----

A T-Wedge can be adjusted to keep the gutter level at various fascia board angles.



## Screen Systems

### NX Drop-In

Part #	Description	Colors	Nom. Gauge/ Thickness	Piece Length	Pieces/ Box	Feet/ Box
--------	-------------	--------	--------------------------	-----------------	----------------	--------------

ALGP5DIML	Aluminum 5" Drop-In	Mill	0.025	4'	50	200'
ALGP6DIML	Aluminum 6" Drop-In	Mill	0.025	4'	50	200'



The front attachment provides a firm hold to the front of the gutter and has a wide mounting flange for a permanent install. The mill finish aluminum screen is micro crimped for enhanced durability.

### NX Lock Small Hole

Part #	Description	Colors	Nom. Gauge/ Thickness	Piece Length	Pieces/ Box	Feet/ Box
--------	-------------	--------	--------------------------	-----------------	----------------	--------------

GGP5LSHBK	Galvanized 5" Lock Small Hole	BK	28 ga	4'	25	100'
GGP6LSHBK	Galvanized 6" Lock Small Hole	BK	28 ga	4'	25	100'
GGP7LSHBK	Galvanized 7" Lock Small Hole	BK	28 ga	4'	25	100'



The small hole screen system installs quickly without disturbing the shingles with its front and back snap lock system.

### NX Lock Regular Hole

Part #	Description	Colors	Nom. Gauge/ Thickness	Piece Length	Pieces/ Box	Feet/ Box
--------	-------------	--------	--------------------------	-----------------	----------------	--------------

GGP5LRHBK	Galv. 5" Lock Regular Hole	BK	28 ga	4'	25	100'
GGP6LRHBK	Galv. 6" Lock Regular Hole	BK	28 ga	4'	25	100'



The regular hole screen system installs quickly without disturbing the shingles with its front and back snap lock system.

# Rainware

## NX Step Down

Part #	Description	Colors	Nom. Gauge/ Thickness	Piece Length	Pieces/ Box	Feet/ Box
GGP5SDBK	Galvanized 5" Step Down	BK	28 ga	4'	25	100'
GGP6SDBK	Galvanized 6" Step Down	BK	28 ga	4'	25	100'



The small hole screen incorporates a raised snap-in system in the back of the gutter to seal off the void between the shingles and the screen. Step Down installs quickly without the use of screws or disturbing the shingles.

## NX Premium Lock

Part #	Description	Colors	Nom. Gauge/ Thickness	Piece Length	Pieces/ Box	Feet/ Box
ALGP5PLBK	Aluminum 5" Premium Lock	BK	0.032	4'	25	100'
ALGP6PLBK	Aluminum 6" Premium Lock	BK	0.032	4'	25	100'



The tiny holes keeps out small debris, while allowing water to flow through the screen. Two stiffening beads run down the center of the screen for added strength. Installation is quick and easy without disturbing the shingles. The screen locks into place with a raised back and front-tiered mounting system.

## Perforated & Dome

### NX Smooth Flow

Part #	Description	Colors	Nom. Gauge/ Thickness	Piece Length	Pieces/ Box	Feet/ Box
ALGP5SF - -	5" Smooth Flow	BK, WH	0.019	6'	40	240'
ALGP5SFML	5" Smooth Flow	Mill	0.019	6'	40	240'
ALGP510SF -	5" Smooth Flow	B, W	0.019	10'	25	250'
ALGP510SFM	5" Smooth Flow	Mill	0.019	10'	25	250'
ALGP6SF - -	6" Smooth Flow	BK, WH	0.019	6'	40	240'
ALGP6SFML	6" Smooth Flow	Mill	0.019	6'	40	240'
ALGP610SF - -	6" Smooth Flow	B, W	0.019	10'	25	250'
ALGP610SFM	6" Smooth Flow	Mill	0.019	10'	25	250'



The perforated cover installs easily without disturbing the shingles. Product is factory notched for easy overlapping. Dual center ribbed bends provide extra rigidity against expansion and contraction. Six 50-count bags of #6 hex head 3/8 stainless steel painted screws are included.

## NX Master Flow

Part #	Description	Colors	Nom. Gauge/ Thickness	Piece Length	Pieces/ Box	Feet/ Box
ALGP5MFBK	Aluminum 5" Master Flow	BK	0.019	4'	25	100'
ALGP6MFBK	Aluminum 6" Master Flow	BK	0.019	4'	25	100'

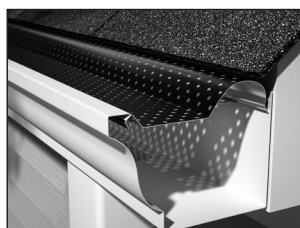

The snap in perforated panels are installed without disturbing the shingles and without the use of screws. The patented curved back portion keeps the contoured front mounting system in place, provides a gentle transition of rainwater on to the panel, blocks debris from depositing in the back of the gutter, and is not obstructed by screw hangers.

## NX Snap-In Dome Cover

Part #	Description	Colors	Nom. Gauge/ Thickness	Piece Box	Pieces/ Box	Feet/ Box
ALGP5SD	Aluminum 5" Snap-In Dome	BK, RB, TB, WH	0.028	4'	14	56'
ALGP6SD	Aluminum 6" Snap-In Dome	BK, RB, TB, WH	0.028	4'	14	56'



This unique solid dome cover is designed for maximum debris load and is one of the easiest dome cover systems to install. The dome cover snaps in without the use of brackets or screws and doesn't disturb the shingles. Snap-In Dome is available in several colors to enhance the curb appeal of your home by blending in with the roof line.

## NX Universal End Caps

Part #	Description	Colors	Nom. Gauge/ Thickness	Pieces/ Box
A5SDUEC	Aluminum 5" Universal End Caps	BK, RB, TB, WH	0.019	10/Bag
A6SDUEC	Aluminum 6" Universal End Caps	BK, RB, TB, WH	0.019	10/Bag



# Rainware

## NX Inside Miter Kit

Part #	Description	Colors	Nom. Gauge/ Thickness	Piece Length	Pieces/ Box
A5SDIMK	Alum. 5" (1 Rt Panel, 1 Lft Panel & 4' Rain Diverter)	BK, RB, TB, WH	0.027	4'	1 pair/box
A6SDIMK	Alum. 6" (1 Rt Panel, 1 Lft Panel & 4' Rain Diverter)	BK, RB, TB, WH	0.027	4'	1 pair/box

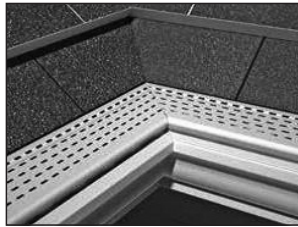

## NX Outside Miter Kit

Part #	Description	Colors	Nom. Gauge/ Thickness	Piece Length	Pieces/ Box
A5SDOMK	Alum. 5" (1 Rt Panel, 1 Lft Panel)	BK, RB, TB, WH	0.027	4'	1 pair/box
A6SDOMK	Alum. 6" (1 Rt Panel, 1 Lft Panel)	BK, RB, TB, WH	0.027	4'	1 pair/box

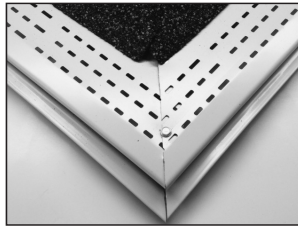

## Gutter Protection

### Gutter Protection

Part #	Description	Colors	Nom. Gauge/ Thickness	Piece Length	Pieces/ Box
ALGLFH5 - -	Aluminum 5"/6" Perforated High-Flow Gutter Cover with Screws 4'	AL, BK, CC, CL, DB, EG, IV, MB, PL, RB, SI, TB, TX, WH	0.024	4'	5
ALGLFS5 - -	Aluminum 5"/6" Standard Solid Gutter Cover with Screws 4'	AL, BK, CC, CL, DB, EG, IV, MB, PL, RB, SI, TB, TX, WH	0.024	4'	25
ALGRX5 - -	Aluminum 5" Drop-In Cover 6'	DB, WH	0.019	6'	50
ALGRX6 - -	Aluminum 6" Drop-In Cover 6'	DB, WH	0.019	6'	50
ALGRX7 - -	Aluminum 7" Drop-In Cover 6'	DB, WH	0.019	6'	50
ALGP5CSWH	Aluminum 5" Clean Sweep 7 1/2'	BK, WH	0.019	7 1/2'	40
ALGP6CSWH	Aluminum 6" Clean Sweep 7 1/2'	BK, WH	0.019	7 1/2'	40

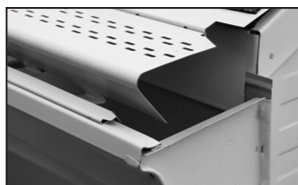

ALGLFH5 High Flow

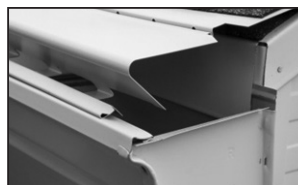

ALGLFS5 Solid



ALGRX5 Drop-In

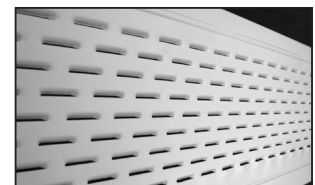

ALGP5CSWH Clean Sweep

## Gutter Protection Accessories

Part #	Description	Colors	Nom. Gauge/ Thickness	Piece Length	Pieces/ Box
ALGLFM5 - -	Miters (set - 1 Left & 1 Right)	AL, BK, CC, CL, DB, EG, IV, MB, PL, RB, SI, TB, TX, WH	0.024		10
ALGLFE5R - -	End Caps (Right)	AL, BK, CC, CL, DB, EG, IV, MB, PL, RB, SI, TB, TX, WH	0.024	5"	25
ALGLFE5L - -	End Caps (Left)	AL, BK, CC, CL, DB, EG, IV, MB, PL, RB, SI, TB, TX, WH	0.024	5"	25

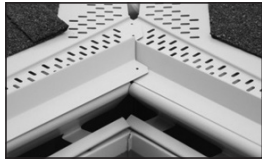

ALGLFM5 Miters



ALGLFE5 R/L End Caps

## Touch Up Paint

ACM Color	Part #	ACM Color	Part #
80 Deg White	TU80	Egg Shell	TUES
30 Deg White	TUFR	Everest (Gray)	TUEV
Almond	TUAL	Musket Brown	TUMB
Bronze	TUBZ	Royal Brown	TURB
Classic Cream	TUCC	Sandtone	TUST
Evergreen	TUEG	Black	TUBK



## Gutter Wedges

Color	5"	6"
White Gutter Wedge 5"	GW5WH	GW6WH

## Aluminum Pop Rivets 1/8" x 3/8"

Color	Part #	Color	Part #
White	APRWH	Everest (Gray)	APREV
Almond	APRAL	Musket Brown	APRMB
Bronze	APRBZ	Royal Brown	APRRB
Classic Cream	APRCC	Sandtone	APRST
Evergreen	APREG	Black	APRBK
Egg Shell	APRES		

## Galvanized #8 x 1/2" HWH SMS

Color	Part #	Color	Part #
80 Deg White	GSC12BH80	Egg Shell	GSC12BHES
30 Deg White	GSC12BHFR	Everest (Gray)	GSC12BHEV
Almond	GSC12BHAL	Musket Brown	GSC12BHMB
Bronze	GSC12BHBZ	Royal Brown	GSC12BHRB
Classic Cream	GSC12BHCC	Sandstone	GSC12BHST
Evergreen	GSC12BHEG	Black	GSC12BHBK



# Rainware

## Coil

### Smooth Coil Conversion Chart

Weight Per Foot (In Pounds)											
Thickness	Width										
	2"	8"	12"	14"	15"	16"	17½"	20"	24"	36"	48"
0.019	0.045	0.181	0.271	0.316	0.339	0.361	0.395	0.451	0.542	0.813	1.083
0.024	0.057	0.228	0.342	0.399	0.428	0.456	0.499	0.570	0.684	1.026	1.369
0.027	0.064	0.257	0.385	0.449	0.481	0.513	0.561	0.642	0.770	1.155	1.540
0.030	0.071	0.285	0.428	0.499	0.535	0.570	0.624	0.713	0.855	1.283	1.711
0.040	0.095	0.380	0.570	0.665	0.713	0.760	0.832	0.950	1.140	1.711	2.281
0.050	0.119	0.475	0.713	0.832	0.891	0.950	1.040	1.188	1.426	2.138	2.851
0.062	0.147	0.589	0.884	1.031	1.105	1.178	1.289	1.473	1.768	2.652	3.535

### Standard Coil Types

Thickness (inches)	Description	Available Widths (inches)
0.014	White/Wash	14
0.019	White/White	16
0.020	Assorted	4 ½
0.024	White/White	2, 8, 16, 20, 24, 36
0.024	White/Ivory	8, 16, 20, 24, 36
0.024	White/Bronze	20
0.024	Bronze/Bronze	8, 16, 20, 24, 36
0.024	White/White Stucco Embossed	24, 36
0.024	Bronze/Bronze Stucco Embossed	24, 36
0.024	White Cedar Embossed	8, 16, 20, 24
0.024	Bronze Cedar Embossed	8, 16, 24
0.024	Ivory/White Cedar Embossed	8, 16, 20
0.024	Brown/White Cedar Embossed	8, 16
0.030	White/White	8, 16
0.030	White/Ivory	16, 20
0.040	White/White	5, 12
0.050	White/White	19
0.040	Mill Finish 3004 Alloy	19
0.050	Mill Finish 3004 Alloy	11¼, 19
0.050	White 3004 Alloy	19
0.063	Mill Finish 3004 Alloy	19

## Miscellaneous Coil Types

Description	Available Widths (inches)
Union Jack Mill Finish	36
Union Jack Bronze	36
Union Jack White	36

# Hurricane Protection

## Risk Category 2 (Typical Residential)

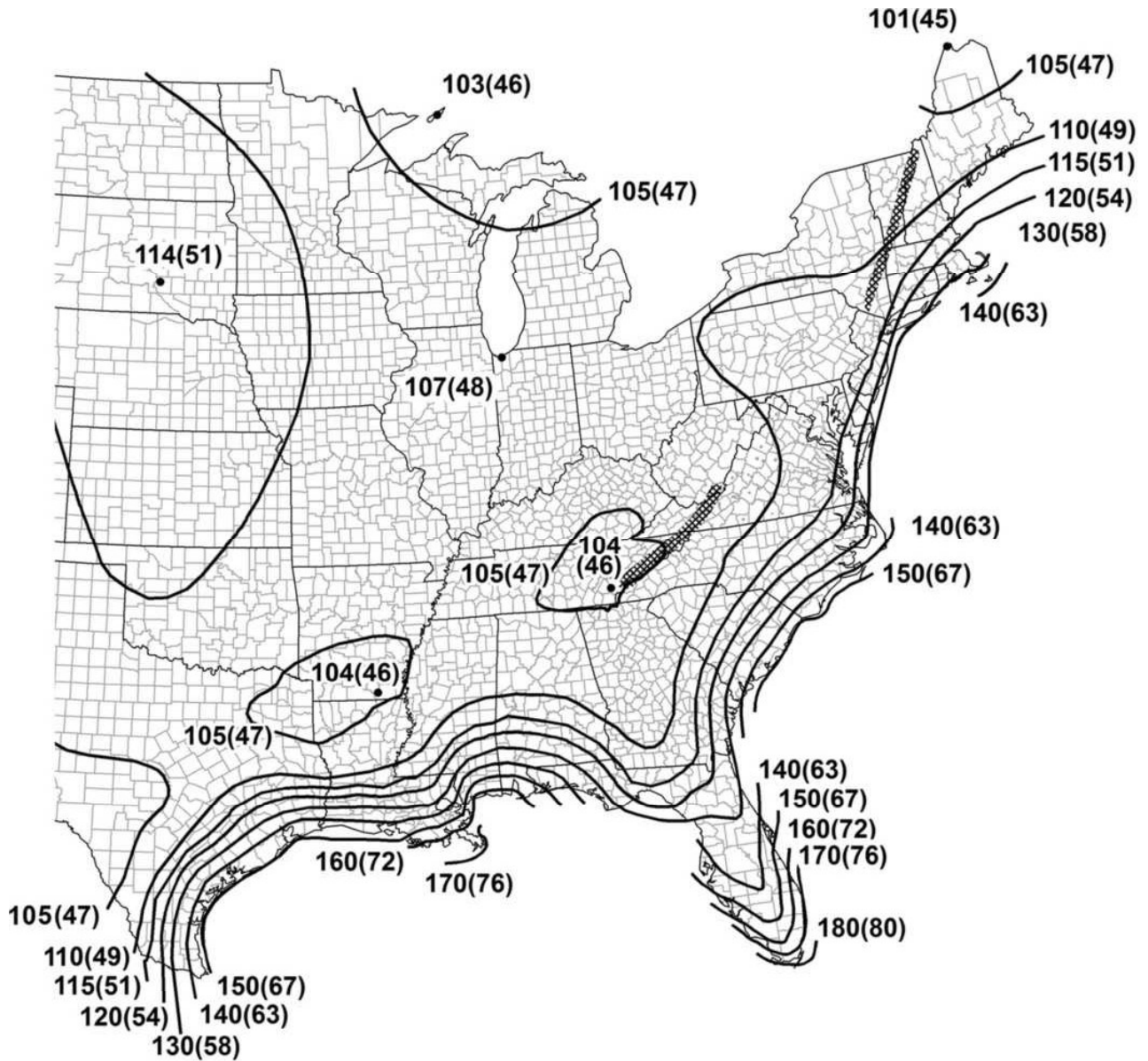

Location	V (mph)	V (m/s)
Guam	195	(87)
Virgin Islands	165	(74)
American Samoa	160	(72)
Hawaii	See Figure 26.5-2B	

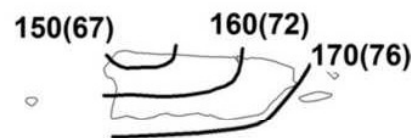

FIGURE 26.5-1B (Continued). Basic Wind Speeds for Risk Category II Buildings and Other Structures

## Risk Category 3 (High Risk Structures)

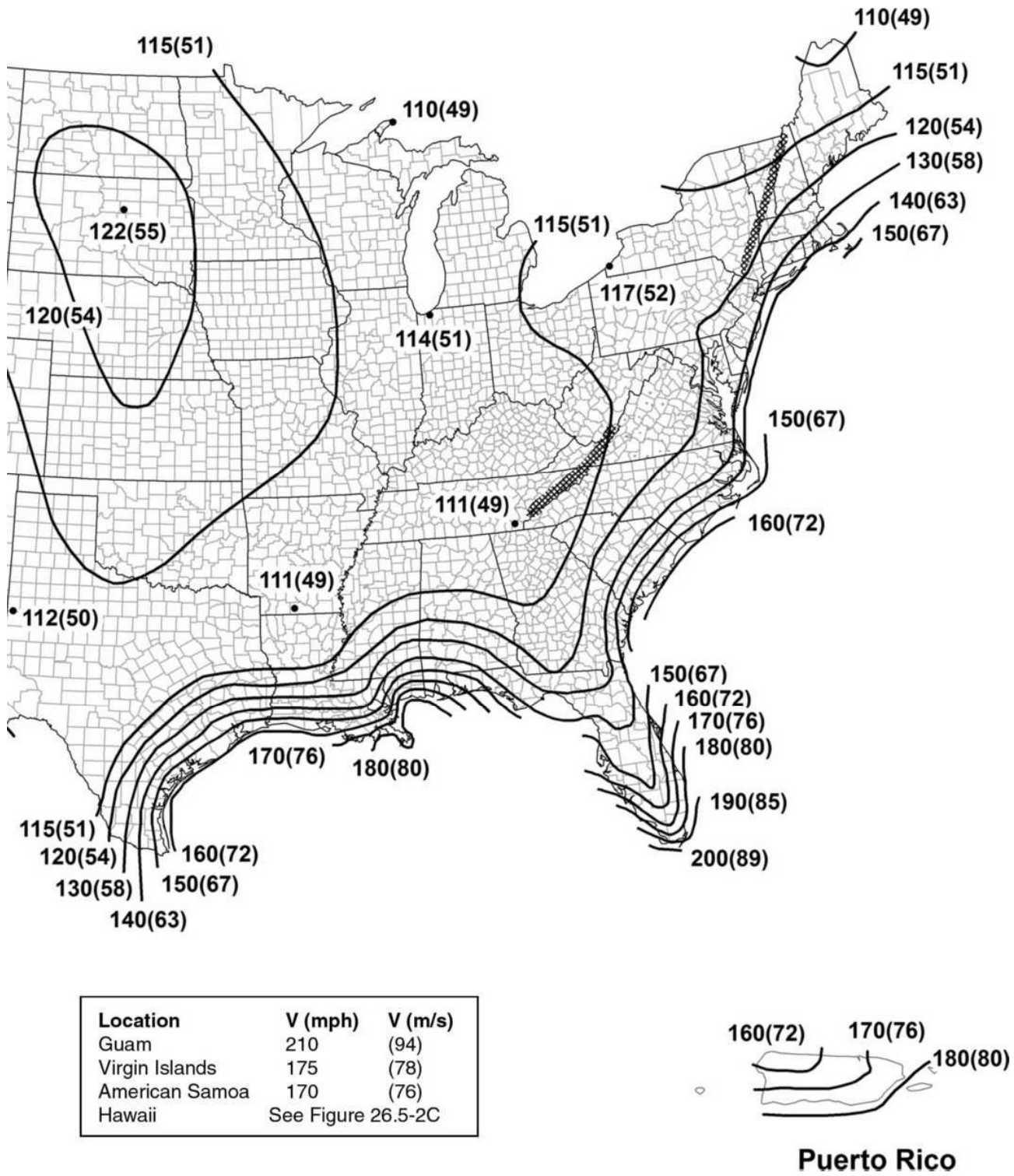

FIGURE 26.5-1C (Continued). Basic Wind Speeds for Risk Category III Buildings and Other Structures

# Hurricane Protection

## Storm Panel Coverage

### Wall Mount

**Number of Panels.....Coverage..... Track Size**

1	13.25	15
1 ½	19.25	21
2	25.25	27
2 ½	31.25	33
3	37.25	39
3 ½	43.25	45
4	49.25	51
4 ½	55.25	57
5	61.25	63
5 ½	67.25	69
6	73.25	75
6 ½	79.25	81
7	85.25	87
7 ½	91.25	93
8	97.25	99
8 ½	103.25	105
9	109.25	111
9 ½	115.25	117
10	121.25	123
10 ½	127.25	129
11	133.25	135
11 ½	139.25	141
12	145.25	147
12 ½	151.25	153
13	157.25	159
13 ½	163.25	165
14	169.25	171
14 ½	175.25	177
15	181.25	183

**Number of Panels.....Coverage..... Track Size**

15 ½	187.25	189
16	193.25	195
16 ½	199.25	201
17	205.25	207
17 ½	211.25	213
18	217.25	219
18 ½	223.25	225
19	229.25	231
19 ½	235.25	237
20	241.25	243
20 ½	247.25	249
21	253.25	255
21 ½	259.25	261
22	265.25	267
22 ½	271.25	273
23	277.25	279
23 ½	283.25	285
24	289.25	291
24 ½	295.25	297
25	301.25	303
25 ½	307.25	309
26	313.25	315
26 ½	319.25	321
27	325.25	327
27 ½	331.25	333
28	337.25	339
28 ½	343.25	345

- For track sizes add 1¾" to above sizes
- Half size steel panels not available at all locations
- Overlap steel panels for half panel coverage if needed



## Trap Mount

**Number of Panels ..... Coverage ..... Track Size**

1	14.25	15
1 ½	20.25	21
2	26.25	27
2 ½	32.25	33
3	38.25	39
3 ½	44.25	45
4	50.25	51
4 ½	56.25	57
5	62.25	63
5 ½	68.25	69
6	74.25	75
6 ½	80.25	81
7	86.25	87
7 ½	92.25	93
8	98.25	99
8 ½	104.25	105
9	110.25	111
9 ½	116.25	117
10	122.25	123
10 ½	128.25	129
11	134.25	135
11 ½	140.25	141
12	146.25	147
12 ½	152.25	153
13	158.25	159
13 ½	164.25	165
14	170.25	171
14 ½	176.25	177
15	182.25	183
15 ½	188.25	189
16	194.25	195
16 ½	200.25	201
17	206.25	207
17 ½	212.25	213
18	218.25	219
18 ½	224.25	225
19	230.25	231
19 ½	236.25	237
20	242.25	243
20 ½	248.25	249
21	254.25	255
21 ½	260.25	261
22	266.25	267
22 ½	272.25	273
23	278.25	279
23 ½	284.25	285
24	290.25	291
24 ½	296.25	297
25	302.25	303
25 ½	308.25	309
26	314.25	315
26 ½	320.25	321
27	326.25	327
27 ½	332.25	333
28	338.25	339
28 ½	344.25	345

### Coverage by additional panels:

Each full panel adds 12"

Each half panel adds 6"

#### One Full Panel

UNIT WIDTH = 14 ¼"



#### One And A Half Panels

UNIT WIDTH = 20 ¼"

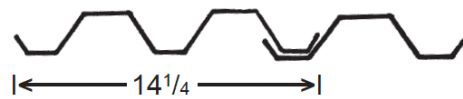

#### Two Full Panels

UNIT WIDTH = 26 ¼"

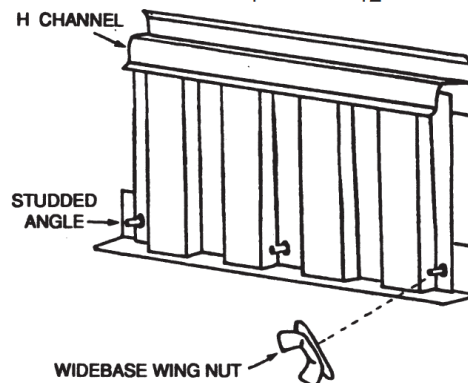
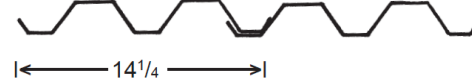

# Hurricane Protection

## 2" Storm Panels

### .050 Aluminum

Part #	Type	Size
3002000	Mill	Full Panel
3003000	Mill	Half Panel
3002300	White	Full Panel
3003300	White	Half Panel

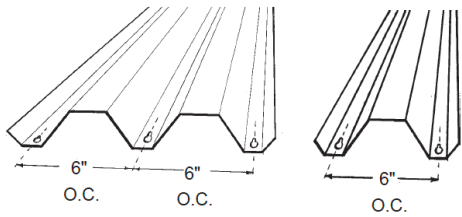

### .0615 Aluminum

Part #	Type	Size
3004000	Mill	Full Panel

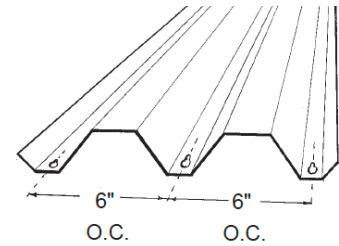

### 24 Gauge Galv Steel "Hemmed"

Part #	Type	Size
3010000CDE	Galv	Full Panel
3010001	Galv	Half Panel
3010252CDE	Galv	252" Full Panel
3008721	Galv	252" Half Panel

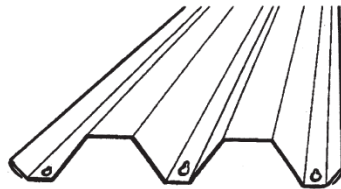

### 28 Gauge Galv Steel "Hemmed"

Part #	Type	Size
3005000	Galv	Full Panel

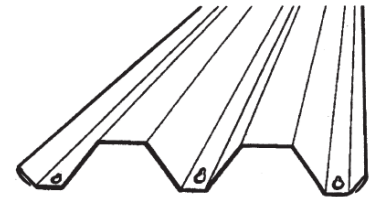

### Clear Polycarbonate 20' Length

Part #	Type	Size
2902020	Clearguard	Full Panel

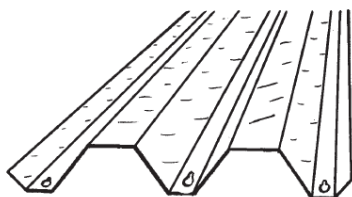

# Storm Panels Accessories & Extrusions

## Aluminum Wedges

**Part #**

2590000

*Does not meet code*

*Special Order Only*

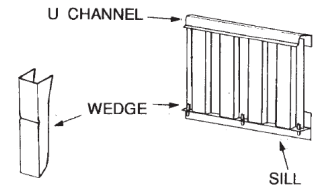

## Heavy 2" H Channel

Size	White	Bronze	Ivory
20.25	1290320	1290220	1290620*

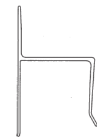

## Heavy 2" U Channel

Size	White	Bronze
20.25	1286320	1286220



## 1" Build Out U Header

Size	White	Bronze
20.25	1275320	1275220

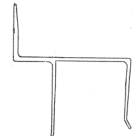

## 2" Build Out U Header

Size	White	Bronze
20.25	1277320	1277220

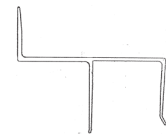

## 3" Build Out U Header

Size	White	Bronze
20.25	1278320	1278220*

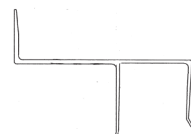

\* not in stock

# Hurricane Protection

## 2 x 2 x .090 Studded Angle

On Center	Size	White	Bronze
6"	20.25'	1254320	1254220
12"	20.25'	1258320	1258220

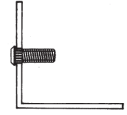

## 2 x 2 x .090 Studded Angle Reverse

On Center	Size	White	Bronze
6"	20.25'	1256320	1256220
12"	20.25'	1260320	1260220

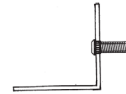

## 2 x 2 x .125 Studded Angle

On Center	Size	White	Bronze
6"	20.25'	1261320	1261220
12"	20.25'	1262320	1262220

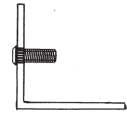

## 1 3/4 x 5/8 x .090 Studded Angle

On Center	Size	White	Bronze
6"	24'	1251324*	1251224
12"	24'	1250324*	1250224

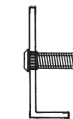

## F Track

Size	White	Bronze	Ivory
20.25'	1268320	1268220	1268620

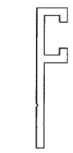

## 2 x 2 F Track Angle

Size	White	Bronze
20.25'	1270320	1270220
24"	1270324	1270324

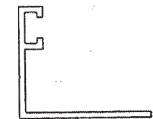

## 2 x 2 F Track Angle Reverse

Size	White	Bronze
20.25'	1271320	1271220
24"	1271324	1271224**

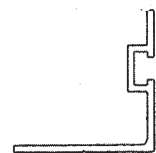

\* not in stock

\*\* available at limited locations

### 1" Build Out F Track

Size	White	Bronze
20.25'	1272320	1272220
24"	1272324	1272224

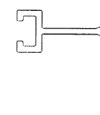

### 2" Build Out F Track

Size	White	Bronze
20.25'	1273320	1273220
24"	1273324	1273224

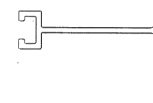

### 3" Build Out F Track

Size	White	Bronze
20.25'	1274320	1274220
24"	1274324	1274224



### 1/4 - 20 x 1" F Track Bolts

**Part #**

2406000

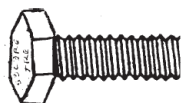

### 1/4 - 20 x 3/4" F Track Bolts

**Part #**

LN04282

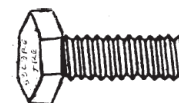

### Wide Base Wing Nuts

**Part #**

2430000/each  
24300PC/bag of 100



### Super Wide Base Wing Nuts

(for 28ga panels only)

**Part #**

243001/each  
2430001PC/bag of 100



### Stud Caps for Stud Angle

**Part #**      **Size**

2587000      3/4"

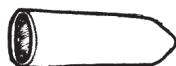

# Hurricane Protection

## Storm Panel Coil

### Coil

Code	Thickness	Color	Width
4042	.040	Mill Finish 3004	19"
4048	.050	Mill Finish 3004	19"
4052	.050	White 3004	19"
4054	.0615	Mill Finish 3004	19"
4058	28 gauge	Galv. Steel	19"
4068	24 gauge	Galv. Steel	19"

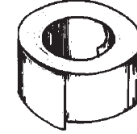

### Coil Conversion Chart

Weight Per Foot (In Pounds)											
Thickness	Width										
	8"	12"	14"	15"	16"	17½"	19"	20"	24"	36"	48"
.019	.179	.268	.313	.335	.358	.391	.425	.447	.537	.805	1.073
.024	.230	.346	.395	.424	.461	.504	.548	.576	.692	1.038	1.384
.027	.258	.388	.445	.477	.517	.565	.614	.646	.776	1.164	1.552
.030	.287	.432	.494	.530	.576	.629	.684	.719	.864	1.296	1.728
.040	.377	.565	.659	.706	.753	.824	.895	.942	1.130	1.695	2.260
.050	.471	.706	.824	.883	.942	1.030	1.118	1.177	1.413	2.119	2.825
.062	.594	.893	1.021	1.095	1.191	1.301	1.414	1.487	1.786	2.679	3.572

# Accordion Shutters

## 6.8 BLADE .421lb/ft

Size	Bronze	White	Ivory	Beige
14.5'	8350214	8350314	8350614	8350814
16.5'	8350216	8350316	8350616	8350816
18'	8350218	8350318	8350618	8350818



## 6.8 STACK CONNECTOR .359lb/ft\*\*

Size	Bronze	White	Ivory	Beige
16.5'	8352216	8352316	8352616	8352816



## Streamline Blade .395lb/ft

Size	Bronze	White	Ivory	Beige
18'	8330218	8330318	8330618	8330818

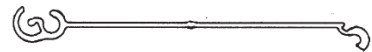

## Streamline Stack Connector .368lb/ft\*

Size	Bronze	White	Ivory	Beige
------	--------	-------	-------	-------



## HR Connector .401lb/ft\*\*

Size	Bronze	White	Ivory	Beige
18'	8341218	8341318	8341618	8341818



## HR Blade .462lb/ft\*\*

Size	Bronze	White	Ivory	Beige
16.5'	8351216	8351316	8351616	8351816

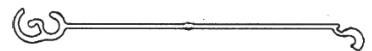

## 6.8 & HR Combo Starter Strip .167lb/ft

Size	Bronze	White	Ivory	Beige
16.5'	8355216	8355316	8355616	8355816
18'	8355218	8355318	8355618	8355818



## E.A. 1" Light End Strip .533lb/ft

Size	Bronze	White	Ivory	Beige
17'	8396217	8396317	8396617	8396817



\* not in stock

\*\* available at limited locations

# Hurricane Protection

## E.A. 2" Light End Strip .612lb/ft

Size	Bronze	White	Ivory	Beige
17'	8397217	8397317	8397617	8397817



## 6.8 Unimate .628lb/ft

Size	Bronze	White	Ivory	Beige
16.5'	8376216	8376316	8376616	8376816
18'	8376218	8376318	8376618	8376818

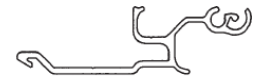

## Male Box Center .769lb/ft

Size	Bronze	White	Ivory	Beige
24.17'	8346224	8346324	8346624	8346824

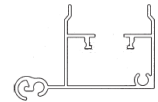

## Female Box Center .808lb/ft

Size	Bronze	White	Ivory	Beige
24.17'	8347224	8347324	8347624	8347824

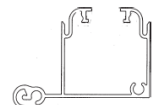

## Box Center Insert .222lb/ft

Size	Bronze	White	Ivory	Beige
24.17'	8345224	8345324	8345624	8345824

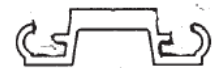

## 6.8 & HR Centermate Left (Inside) .841lb/ft\*

Size	Bronze	White	Ivory	Beige
24.17'	8342224	8342324	8342624	8342824



## 6.8 & HR Centermate Right (Outside) .841lb/ft\*

Size	Bronze	White	Ivory	Beige
24.17'	8344224	8344324	8344624	8344824

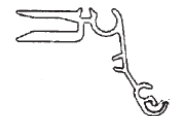

## Streamline Ceiling/Sill .685 lb/ft

Size	Bronze	White	Ivory	Beige
20.5'	8338220	8338320	8338620	8338820

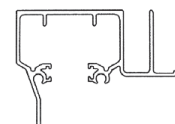

\* not in stock

### E.A. Heavy Ceiling Header .866 lb/ft

Size	Bronze	White	Ivory	Beige
20.5'	8378220	8378320	8378620	8378820

*Used for Streamline, 6.8 and HR Shutters.*

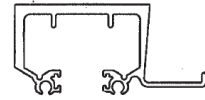

### 6.8/HR STD 90° Ceiling Track .866 lb/ft

Bronze	White	Ivory	Beige
8440290	8440390	8440690	8440890

*Used for Streamline, 6.8 and HR Shutters.*

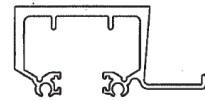

### 6.8/HR REV 90° Ceiling Track .944 lb/ft

Bronze	White	Ivory	Beige
8441290	8441390	8441690	8441890

*Used for Streamline, 6.8 and HR Shutters.*

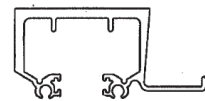

### 6.8/HR STD 45° Ceiling Track .944 lb/ft

Bronze	White	Ivory	Beige
8442245	8442345	8442645	8442845

*Used for Streamline, 6.8 and HR Shutters.*

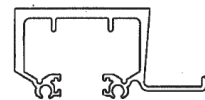

### 6.8/HR REV 45° Ceiling Track .944 lb/ft

Bronze	White	Ivory	Beige
8443245	8443345	8443645	8443845

*Used for Streamline, 6.8 and HR Shutters.*

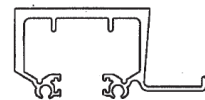

### E.F. Ceiling Header 1.085lb/ft (Special Order Only)

Size	Bronze	White	Ivory	Beige
20.5'	8359220	8359320	8359620	8359820

*Used for Streamline, 6.8 and HR Shutters.*

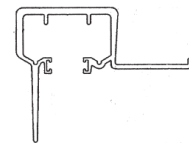

### E.A. Sill .757 lb/ft

Size	Bronze	White	Ivory	Beige
20.5'	8380220	8380320	8380620	8380820

*Used for Streamline, 6.8 and HR Shutters.*

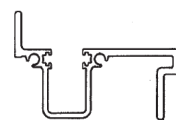

# Hurricane Protection

## 6.8 Sill Adapter .995 lb/ft

Size	Bronze	White	Ivory	Beige
20.5'	8362220	8362320	8362620	8362820

*Used for Streamline, 6.8 and HR Shutters.*

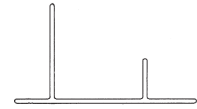

## E.A. Mid Sill .732 lb/ft (Special Order Only)

Size	Bronze	White	Ivory	Beige
20.5'	8385220	8385320	8385620	8385820

*Used for Streamline, 6.8 and HR Shutters.*

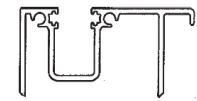

## E.A. Mid Adapter .760 lb/ft (Special Order Only)

Bronze	White	Ivory	Beige
8386220	8386320	8386620	8386820

*Used for Streamline, 6.8 and HR Shutters.*



## E.A. Extended Sill 1.121 lb/ft

Size	Bronze	White	Ivory	Beige
20.5'	8381220	8381320	8381620	8381820

*Used for Streamline, 6.8 and HR Shutters.*

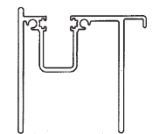

## 6.8 Extended Adapter 1.160 lb/ft

Size	Bronze	White	Ivory	Beige
20.5'	8363220	8363320	8363620	8363820

*Used for Streamline, 6.8 and HR Shutters.*

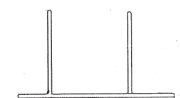

## Streamline Adapter .650 lb/ft

Size	Bronze	White	Ivory	Beige
20.5'	8336220	8336320	8336620	8336820

*Used for Streamline, 6.8 and HR Shutters.*



## E.A. Decorative Floor Track .936 lb/ft

Size	Bronze	White	Ivory	Beige
20.5'	8392220	8392320	8392620	8392820

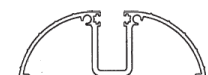

**E.A. Rainguard 1.720 lb/ft**

Size	Bronze	White	Ivory	Beige
20.5'	8372220	8372320	8372620	8372820

*Used for Streamline, 6.8 and HR Shutters.*



**E.A. Recessed Sill .325 lb/ft**

Size	White	Anodized
20.5'	8391320	8391120

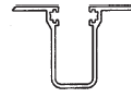

**2 Leg Wall Header 1.258 lb/ft**

Size	Bronze	White	Ivory	Beige
20.5'	8364220	8364320	8364620	8364820

*Used for Streamline, 6.8 and HR Shutters.*

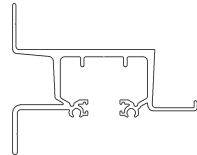

**Streamline 1 Leg Wall Header .840 lb/ft**

Size	Bronze	White	Ivory	Beige
20.5'	8334220	8334320	8334620	8334820

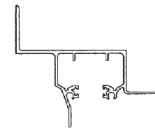

**E.A. Leg Wall Track .949 lb/ft**

Size	Bronze	White	Ivory	Beige
20.5'	8387220	8387320	8387620	8387820

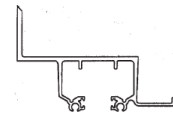

**E.A. 2" Build Out Wall Track 1.324 lb/ft**

Size	Bronze	White	Ivory	Beige
20.5'	8389220	8389320	8389620	8389820

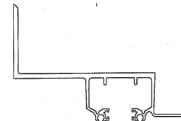

**E.A. 3" Build Out Wall Track 1.324 lb/ft\***

Size	Bronze	White	Ivory	Beige
20.5'	83990220	83990320	83990620	83990820

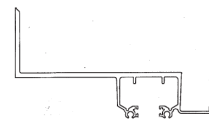

\* not in stock

# Hurricane Protection

## Accordion Spread Sheet

### Streamline with Unimates

Max Daylight Opening	No. Of Blades	Max Shutter Spread	Max Daylight Opening	No. Of Blades	Max Shutter Spread
18.21	5	21.73	277.904	87	302.17
24.544	7	28.57	284.238	89	309.01
30.878	9	35.41	290.572	91	315.85
37.212	11	42.25	296.906	93	322.69
43.546	13	49.09	303.24	95	329.53
49.88	15	55.93	309.574	97	336.37
56.214	17	62.77	315.908	99	343.21
62.548	19	69.61	322.242	101	350.05
68.882	21	76.45	328.576	103	356.89
75.216	23	83.29	334.91	105	363.73
81.55	25	90.13	341.244	107	370.57
87.884	27	96.97	347.578	109	377.41
94.218	29	103.81	353.912	111	384.25
100.552	31	110.65	360.246	113	391.09
106.886	33	117.49	366.58	115	397.93
113.22	35	124.33	372.914	117	404.77
119.554	37	131.17	379.248	119	411.61
125.888	39	138.01	385.582	121	418.45
132.222	41	144.85	391.916	123	425.29
138.556	43	151.69	398.25	125	432.13
144.89	45	158.53	404.584	127	438.97
151.224	47	165.37	410.918	129	445.81
157.558	49	172.21	417.252	131	452.65
163.892	51	179.05	423.586	133	459.49
170.226	53	185.89	429.92	135	466.33
176.56	55	192.73	436.254	137	473.17
182.894	57	199.57	442.588	139	480.01
189.228	59	206.41	448.922	141	486.85
195.562	61	213.25	455.256	143	493.69
201.896	63	220.09	461.59	145	500.53
208.23	65	226.93	467.924	147	507.37
214.564	67	233.77	474.258	149	514.21
220.898	69	240.61	480.592	151	521.05
227.232	71	247.45	486.926	153	527.89
233.566	73	254.29	493.26	155	534.73
239.9	75	261.13	499.594	157	541.57
246.234	77	267.97	505.928	159	548.41
252.568	79	274.81	512.262	161	555.25
258.902	81	281.65	518.596	163	562.09
265.236	83	288.49	524.93	165	568.93
271.57	85	295.33			

*This is an approximated spread sheet! Number of blades plus two centers equals max spread. Tracks need to be slightly shorter . All shutters should be measured after assembly to verify proper track size. Shutter blades vary according to die life. Blades can range from 6.8 To 7.05" per pair. Spread out over 20 pairs, this can reflect a 5" variance.*



## Streamline with Box Centers Spread Sheet

Max Daylight Opening	No. Of Blades	Max Shutter Spread	Stack (Approx. size)	Max Daylight Opening	No. Of Blades	Max Shutter Spread	Stack (Approx. size)
12.299	4	17.63	5.33	271.993	86	298.07	26.08
18.633	6	24.47	5.84	278.327	88	304.91	26.58
24.967	8	31.31	6.34	284.661	90	311.75	27.09
31.301	10	38.15	6.85	290.995	92	318.59	27.60
37.635	12	44.99	7.36	297.329	94	325.43	28.10
43.969	14	51.83	7.86	303.663	96	332.27	28.61
50.303	16	58.67	8.37	309.997	98	339.11	29.11
56.637	18	65.51	8.87	316.331	100	345.95	29.62
62.971	20	72.35	9.38	322.665	102	352.79	30.13
69.305	22	79.19	9.89	328.999	104	359.63	30.63
75.639	24	86.03	10.39	335.333	106	366.47	31.14
81.973	26	92.87	10.90	341.667	108	373.31	31.64
88.307	28	99.71	11.40	348.001	110	380.15	32.15
94.641	30	106.55	11.91	354.335	112	386.99	32.66
100.975	32	113.39	12.42	360.669	114	393.83	33.16
107.309	34	120.23	12.92	367.003	116	400.67	33.67
113.643	36	127.07	13.43	373.337	118	407.51	34.17
119.977	38	133.91	13.93	379.671	120	414.35	34.68
126.311	40	140.75	14.44	386.005	122	421.19	35.19
132.645	42	147.59	14.95	392.339	124	428.03	35.69
138.979	44	154.43	15.45	398.673	126	434.87	36.20
145.313	46	161.27	15.96	405.007	128	441.71	36.70
151.647	48	168.11	16.46	411.341	130	448.55	37.21
157.981	50	174.95	16.97	417.675	132	455.39	37.72
164.315	52	181.79	17.48	424.009	134	462.23	38.22
170.649	54	188.63	17.98	430.343	136	469.07	38.73
176.983	56	195.47	18.49	436.677	138	475.91	39.23
183.317	58	202.31	18.99	443.011	140	482.75	39.74
189.651	60	209.15	19.50	449.345	142	489.59	40.25
195.985	62	215.99	20.01	455.679	144	496.43	40.75
202.319	64	222.83	20.51	462.013	146	503.27	41.26
208.653	66	229.67	21.02	468.347	148	510.11	41.76
214.987	68	236.51	21.52	474.681	150	516.95	42.27
221.321	70	243.35	22.03	481.015	152	523.79	42.78
227.655	72	250.19	22.54	487.349	154	530.63	43.28
233.989	74	257.03	23.04	493.683	156	537.47	43.79
240.323	76	263.87	23.55	500.017	158	544.31	44.29
246.657	78	270.71	24.05	506.351	160	551.15	44.80
252.991	80	277.55	24.56	512.685	162	557.99	45.30
259.325	82	284.39	25.07	519.019	164	564.83	45.81
265.659	84	291.23	25.57				

*This is an approximated spread sheet! Number of blades plus two centers equals max spread. Tracks need to be slightly shorter. All shutters should be measured after assembly to verify proper track size. Shutter blades vary according to die life. Blades can range from 6.8 To 7.05 per pair. Spread out over 20 pairs, this can reflect a 5" variance.*

# Hurricane Protection

## Unimate 6.8 Spread Sheet

Max Daylight Opening	No. Of Blades	Max Shutter Spread	Max Daylight Opening	No. Of Blades	Max Shutter Spread
18.11	5	21.63	276.164	87	300.51
24.404	7	28.43	282.458	89	307.31
30.698	9	35.23	288.752	91	314.12
36.992	11	42.04	295.046	93	320.92
43.286	13	48.84	301.34	95	327.72
49.58	15	55.64	307.634	97	334.52
55.874	17	62.44	313.928	99	341.32
62.168	19	69.24	320.222	101	348.13
68.462	21	76.05	326.516	103	354.93
74.756	23	82.85	332.81	105	361.73
81.05	25	89.65	339.104	107	368.53
87.344	27	96.45	345.398	109	375.33
93.638	29	103.25	351.692	111	382.14
99.932	31	110.06	357.986	113	388.94
106.226	33	116.86	364.28	115	395.74
112.52	35	123.66	370.574	117	402.54
118.814	37	130.46	376.868	119	409.34
125.108	39	137.26	383.162	121	416.15
131.402	41	144.07	389.456	123	422.95
137.696	43	150.87	395.75	125	429.75
143.99	45	157.67	402.044	127	436.55
150.284	47	164.47	408.338	129	443.35
156.578	49	171.27	414.632	131	450.16
162.872	51	178.08	420.926	133	456.96
169.166	53	184.88	427.22	135	463.76
175.46	55	191.68	433.514	137	470.56
181.754	57	198.48	439.808	139	477.36
188.048	59	205.28	446.102	141	484.17
194.342	61	212.09	452.396	143	490.97
200.636	63	218.89	458.69	145	497.77
206.93	65	225.69	464.984	147	504.57
213.224	67	232.49	471.278	149	511.37
219.518	69	239.29	477.572	151	518.18
225.812	71	246.10	483.866	153	524.98
232.106	73	252.90	490.16	155	531.78
238.4	75	259.70	496.454	157	538.58
244.694	77	266.50	502.748	159	545.38
250.988	79	273.30	509.042	161	552.19
257.282	81	280.11	515.336	163	558.99
263.576	83	286.91	521.63	165	565.79
269.87	85	293.71			

*This is an approximated spread sheet! Number of blades plus two centers equals max spread. Tracks need to be slightly shorter . All shutters should be measured after assembly to verify proper track size. Shutter blades vary according to die life. Blades can range from 6.7 To 6.98 per pair. Spread out over 20 pairs, this can reflect a 5" variance.*



### 6.8 Box Spread Sheet This sheet applies only for the box centers.\*

Max Daylight Opening	No. Of Blades	Max Shutter Spread	Stack (Approx. size)	Max Daylight Opening	No. Of Blades	Max Shutter Spread	Stack (Approx. size)
12.155	4	17.49	5.34	270.455	86	296.62	26.16
18.455	6	24.30	5.84	276.755	88	303.43	26.67
24.755	8	31.11	6.35	283.055	90	310.23	27.18
31.055	10	37.91	6.86	289.355	92	317.04	27.69
37.355	12	44.72	7.37	295.655	94	323.85	28.20
43.655	14	51.53	7.88	301.955	96	330.66	28.70
49.955	16	58.34	8.38	308.255	98	337.47	29.21
56.255	18	65.15	8.89	314.555	100	344.27	29.72
62.555	20	71.95	9.40	320.855	102	351.08	30.23
68.855	22	78.76	9.91	327.155	104	357.89	30.74
75.155	24	85.57	10.42	333.455	106	364.70	31.24
81.455	26	92.38	10.92	339.755	108	371.51	31.75
87.755	28	99.19	11.43	346.055	110	378.31	32.26
94.055	30	105.99	11.94	352.355	112	385.12	32.77
100.355	32	112.80	12.45	358.655	114	391.93	33.28
106.655	34	119.61	12.96	364.955	116	398.74	33.78
112.955	36	126.42	13.46	371.255	118	405.55	34.29
119.255	38	133.23	13.97	377.555	120	412.35	34.80
125.555	40	140.03	14.48	383.855	122	419.16	35.31
131.855	42	146.84	14.99	390.155	124	425.97	35.82
138.155	44	153.65	15.50	396.455	126	432.78	36.32
144.455	46	160.46	16.00	402.755	128	439.59	36.83
150.755	48	167.27	16.51	409.055	130	446.39	37.34
157.055	50	174.07	17.02	415.355	132	453.20	37.85
163.355	52	180.88	17.53	421.655	134	460.01	38.36
169.655	54	187.69	18.04	427.955	136	466.82	38.86
175.955	56	194.50	18.54	434.255	138	473.63	39.37
182.255	58	201.31	19.05	440.555	140	480.43	39.88
188.555	60	208.11	19.56	446.855	142	487.24	40.39
194.855	62	214.92	20.07	453.155	144	494.05	40.90
201.155	64	221.73	20.58	459.455	146	500.86	41.40
207.455	66	228.54	21.08	465.755	148	507.67	41.91
213.755	68	235.35	21.59	472.055	150	514.47	42.42
220.055	70	242.15	22.10	478.355	152	521.28	42.93
226.355	72	248.96	22.61	484.655	154	528.09	43.44
232.655	74	255.77	23.12	490.955	156	534.90	43.94
238.955	76	262.58	23.62	497.255	158	541.71	44.45
245.255	78	269.39	24.13	503.555	160	548.51	44.96
251.555	80	276.19	24.64	509.855	162	555.32	45.47
257.855	82	283.00	25.15	516.155	164	562.13	45.98
264.155	84	289.81	25.66				

*This is an approximated spread sheet! Number of blades plus two centers equals max spread. Tracks need to be slightly shorter. All shutters should be measured after assembly to verify proper track size. Shutter blades vary according to die life. Blades can range from 6.7 To 6.98" per pair. Spread out over 20 pairs, this can reflect a 5" variance.*

# Hurricane Protection

**HR Box Center Spread Sheet** This sheet applies only for the box centers.\*

Max Daylight Opening	No. Of Blades	Max Shutter Spread	Max Daylight Opening	No. Of Blades	Max Shutter Spread
9.724	4	14.99	221.776	86	245.41
14.896	6	20.61	226.948	88	251.03
20.068	8	26.23	232.12	90	256.65
25.24	10	31.85	237.292	92	262.27
30.412	12	37.47	242.464	94	267.89
35.584	14	43.09	247.636	96	273.51
40.756	16	48.71	252.808	98	279.13
45.928	18	54.33	257.98	100	284.75
51.1	20	59.95	263.152	102	290.37
56.272	22	65.57	268.324	104	295.99
61.444	24	71.19	273.496	106	301.61
66.616	26	76.81	278.668	108	307.23
71.788	28	82.43	283.84	110	312.85
76.96	30	88.05	289.012	112	318.47
82.132	32	93.67	294.184	114	324.09
87.304	34	99.29	299.356	116	329.71
92.476	36	104.91	304.528	118	335.33
97.648	38	110.53	309.7	120	340.95
102.82	40	116.15	314.872	122	346.57
107.992	42	121.77	320.044	124	352.19
113.164	44	127.39	325.216	126	357.81
118.336	46	133.01	330.388	128	363.43
123.508	48	138.63	335.56	130	369.05
128.68	50	144.25	340.732	132	374.67
133.852	52	149.87	345.904	134	380.29
139.024	54	155.49	351.076	136	385.91
144.196	56	161.11	356.248	138	391.53
149.368	58	166.73	361.42	140	397.15
154.54	60	172.35	366.592	142	402.77
159.712	62	177.97	371.764	144	408.39
164.884	64	183.59	376.936	146	414.01
170.056	66	189.21	382.108	148	419.63
175.228	68	194.83	387.28	150	425.25
180.4	70	200.45	392.452	152	430.87
185.572	72	206.07	397.624	154	436.49
190.744	74	211.69	402.796	156	442.11
195.916	76	217.31	407.968	158	447.73
201.088	78	222.93	413.14	160	453.35
206.26	80	228.55	418.312	162	458.97
211.432	82	234.17	423.484	164	464.59
216.604	84	239.79			

\*Box centers use even number of blades.

*This is an approximated spread sheet! Number of blades plus two centers equals max spread. Tracks need to be slightly shorter. All shutters should be measured after assembly to verify proper track size. Shutter blades vary according to die life.*



### HR Accordion Spread Sheet Left inside and right outside centers.

No. Of Blades	Stack Size	Opening Size	Max Spread	No. Of Blades	Stack Size	Opening Size	Max Spread
2	4.22	5.275	9.495	84	23.49	216.425	239.915
4	4.69	10.425	15.115	86	23.96	221.575	245.535
6	5.16	15.575	20.735	88	24.43	226.725	251.155
8	5.63	20.725	26.355	90	24.9	231.875	256.775
10	6.1	25.875	31.975	92	25.37	237.025	262.395
12	6.57	31.025	37.595	94	25.84	242.175	268.015
14	7.04	36.175	43.215	96	26.31	247.325	273.635
16	7.51	41.325	48.835	98	26.78	252.475	279.255
18	7.98	46.475	54.455	100	27.25	257.625	284.875
20	8.45	51.625	60.075	102	27.72	262.775	290.495
22	8.92	56.775	65.695	104	28.19	267.925	296.115
24	9.39	61.925	71.315	106	28.66	273.075	301.735
26	9.86	67.075	76.935	108	29.13	278.225	307.355
28	10.33	72.225	82.555	110	29.6	283.375	312.975
30	10.8	77.375	88.175	112	30.07	288.525	318.595
32	11.27	82.525	93.795	114	30.54	293.675	324.215
34	11.74	87.675	99.415	116	31.01	298.825	329.835
36	12.21	92.825	105.035	118	31.48	303.975	335.455
38	12.68	97.975	110.655	120	31.95	309.125	341.075
40	13.15	103.125	116.275	122	32.42	314.275	346.695
42	13.62	108.275	121.895	124	32.89	319.425	352.315
44	14.09	113.425	127.515	126	33.36	324.575	357.935
46	14.56	118.575	133.135	128	33.83	329.725	363.555
48	15.03	123.725	138.755	130	34.3	334.875	369.175
50	15.5	128.875	144.375	132	34.77	340.025	374.795
52	15.97	134.025	149.995	134	35.24	345.175	380.415
54	16.44	139.175	155.615	136	35.71	350.325	386.035
56	16.91	144.325	161.235	138	36.18	355.475	391.655
58	17.38	149.475	166.855	140	36.65	360.625	397.275
60	17.85	154.625	172.475	142	37.12	365.775	402.895
62	18.32	159.775	178.095	144	37.59	370.925	408.515
64	18.79	164.925	183.715	146	38.06	376.075	414.135
66	19.26	170.075	189.335	148	38.53	381.225	419.755
68	19.73	175.225	194.955	150	39	386.375	425.375
70	20.2	180.375	200.575	152	39.47	391.525	430.995
72	20.67	185.525	206.195	154	39.94	396.675	436.615
74	21.14	190.675	211.815	156	40.41	401.825	442.235
76	21.61	195.825	217.435	158	40.88	406.975	447.855
78	22.08	200.975	223.055	160	41.35	412.125	453.475
80	22.55	206.125	228.675	162	41.82	417.275	459.095
82	23.02	211.275	234.295	164	42.29	422.425	464.715

*This is an approximated spread sheet! Number of blades plus two centers equals max spread. Tracks need to be slightly shorter. All shutters should be measured after assembly to verify proper track size. Shutter blades vary according to die life.*

# Hurricane Protection

## HR Accordion Spread Sheet

No. Of Blades	Stack Size	Opening Size	Max Spread	No. Of Blades	Stack Size	Opening Size	Max Spread
166	42.76	427.575	470.335	248	62.03	638.725	700.755
168	43.23	432.725	475.955	250	62.5	643.875	706.375
170	43.7	437.875	481.575	252	62.97	649.025	711.995
172	44.17	443.025	487.195	254	63.44	654.175	717.615
174	44.64	448.175	492.815	256	63.91	659.325	723.235
176	45.11	453.325	498.435	258	64.38	664.475	728.855
178	45.58	458.475	504.055	260	64.85	669.625	734.475
180	46.05	463.625	509.675	262	65.32	674.775	740.095
182	46.52	468.775	515.295	264	65.79	679.925	745.715
184	46.99	473.925	520.915	266	66.26	685.075	751.335
186	47.46	479.075	526.535	268	66.73	690.225	756.955
188	47.93	484.225	532.155	270	67.2	695.375	762.575
190	48.4	489.375	537.775	272	67.67	700.525	768.195
192	48.87	494.525	543.395	274	68.14	705.675	773.815
194	49.34	499.675	549.015	276	68.61	710.825	779.435
196	49.81	504.825	554.635	278	69.08	715.975	785.055
198	50.28	509.975	560.255	280	69.55	721.125	790.675
200	50.75	515.125	565.875	280	69.55	721.125	790.675
202	51.22	520.275	571.495	284	70.49	731.425	801.915
204	51.69	525.425	577.115	286	70.96	736.575	807.535
206	52.16	530.575	582.735	288	71.43	741.725	813.155
208	52.63	535.725	588.355	290	71.9	746.875	818.775
210	53.1	540.875	593.975	292	72.37	752.025	824.395
212	53.57	546.025	599.595				
214	54.04	551.175	605.215				
216	54.51	556.325	610.835				
218	54.98	561.475	616.455				
220	55.45	566.625	622.075				
222	55.92	571.775	627.695				
224	56.39	576.925	633.315				
226	56.86	582.075	638.935				
228	57.33	587.225	644.555				
230	57.8	592.375	650.175				
232	58.27	597.525	655.795				
234	58.74	602.675	661.415				
236	59.21	607.825	667.035				
238	59.68	612.975	672.655				
240	60.15	618.125	678.275				
242	60.62	623.275	683.895				
244	61.09	628.425	689.515				
246	61.56	633.575	695.135				

*This is an approximated spread sheet! Number of blades plus two centers equals max spread. Tracks need to be slightly shorter. All shutters should be measured after assembly to verify proper track size. Shutter blades vary according to die life.*



## Accordion Shutter Accessories

### H-7 Nylon Bushing 1000/Bag

**Part #**

8406000



### #8 Long Heavy Bushing 3000/Box

**White                  Black**

8403000                  8406001



### #9 Short Heavy Bushing 4000/Box

**White                  Black**

8404000                  8406002



### 6.8/HR Nylon Washer 1000/Bag

**White**

8426002



### Accordian Track Cover Universal

**Size                  Bronze                  White                  Ivory                  Beige**

8"                  8438200                  8438300                  8438600                  8438800



### Wheel Assembly 1000/Box

**White**

8424000



### 6.8/HR #14 x 2 3/4" Screw with T&C Ultracote 1000/Box

**Stainless Steel**

8408000



# Hurricane Protection

## Streamline #10 x 2<sup>3</sup>/<sub>4</sub>" Screw with T&C Ultracote 1000/Box

**Stainless Steel**

8409000



## E.A. End Strip Screw 500/Box

**Part #**

8408002



## 6.8 Threaded Thumb Screw Insert 10/Bag

**Mill Finish**

8400004

*\* Cannot be used on outside of shutter*

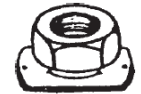

## Large 6.8/HR Thumb Screw 10/Bag

**White**

**Black**

8430005

8430006



## 6.8 Keylock 20/Box

**Bronze**

**White**

**Ivory**

**Beige**

8400200

8400300

8400600

8400800

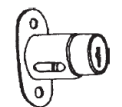

## 6.8 T-Lock Adapter 20/Box

**Bronze**

**White**

**Ivory**

**Beige**

8401200

8401300

8401600

8401800

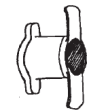

## 6.8 Keylock & Adapter combo 20/box 20/Box

**Bronze**

**White**

**Ivory**

**Beige**

8405200

8405300

8405600

8405800

*\*Available in one box*

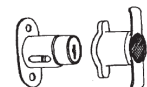

## Thumb Turn Cylinder (Interior Only)

**Part #**

8401001

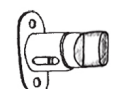

### 6.8/HR Lock

Mill Finish	Stainless Steel
8400005	8400008

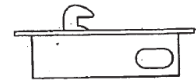

### 6.8/Box Key Cover

Bronze	White	Ivory	Beige
8400209	8400309	8400609	8400809

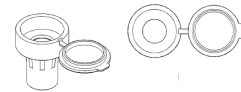

### 6.8/HR Box Center Handle

Black
8413000

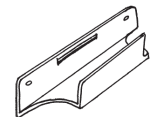

### 6061 Locking Pins 3/8" (for HR only)

Size	Mill Finish
8"	8433008
12"	8433012
24"	8433024
36"	8433036
48"	8433048

*Custom sizes available*



### 6.8/SL/HR Heavy Rod Lock

White	Black
8400096	8400097



### 6.8 Velcro Tiebacks

Bronze	White	Ivory	Beige
8412200	8412300	8412600	8412800



### Felt for Accordion Tracks 3000'/Roll

Part #
2086000



# Hurricane Protection

## FullView, UltraView Bahama and E.A. Colonial Shutters

### Fullview Bahama Blade .310 lb/ft

Part #	Type	Size
8650012	Mill	12.75'
8650312	White	12.75'

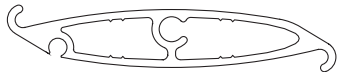

### UltraView Bahama Blade .310 lb/ft

Part #	Type	Size
8651012	Mill	12.75'
8651312	White	12.75'

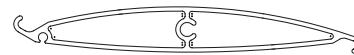

### E.A. Colonial Blade .354 lb/ft

Part #	Type	Size
8670012	Mill	12.75'
8670312	White	12.75'



### Bahama Hinge .480 lb/ft

Part #	Type	Size
8652021	Mill	21.67'
8652321	White	21.67'

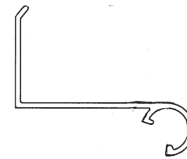

### Bahama Header 1.019 lb/ft

Part #	Type	Size
8654021	Mill	21.67'
8654321	White	21.67'

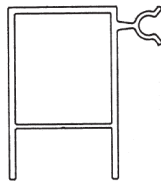

### Bahama/Colonial Sill .798 lb/ft

Part #	Type	Size
8660021	Mill	21.67'
8660321	White	21.67'

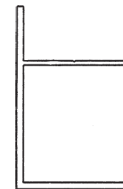

### Fullview Bahama/Colonial Jamb .793 lb/ft

Part #	Type	Size
8657021	Mill	21.5'
8657321	White	21.5'

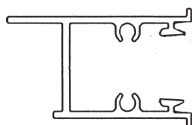

### Bahama/Colonial Jamb Snap .798 lb/ft

Part #	Type	Size
8658021	Mill	21.5'
8658321	White	21.5'



**E.A. Bahama Female Mull .605 lb/ft**

Part #	Type	Size
8663021	Mill	21.5'
8664321	White	21.5'

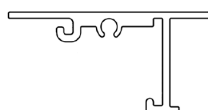

**E.A. Bahama Male Mull .426 lb/ft**

Part #	Type	Size
8665021	Mill	21.5'
8665321	White	21.5'

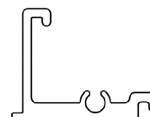

**Bahama Articulating Angle .107 lb/ft**

Part #	Type	Size
8666021	Mill	12.75'
8666321	White	12.75'



**E.A. Colonial Flat Hinge .904 lb/ft**

Part #	Type	Size
8672012	Mill	12.75'
8672312	White	12.75'

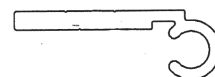

**E.A. Colonial Wall Hinge 1.225 lb/ft**

Part #	Type	Size
8673012	Mill	12.75'
8673312	White	12.75'

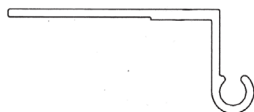

**E.A. Colonial Build Out Wall Hinge 1.420 Lb/Ft**

Part #	Type	Size
8674012	Mill	12.75'
8674312	White	12.75'

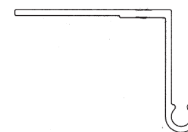

**E.A. Colonial Muntin 1.158 lb/ft**

Part #	Type	Size
8671012	Mill	12.75'
8671312	White	12.75'

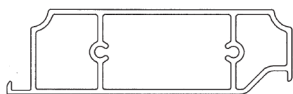

**2 x 3 x 3/16 Angle for Colonial 4" Center Clip 1.090 lb/ft**

Part #	Type	Size
5192025	Mill	25'
5192325	White	25'

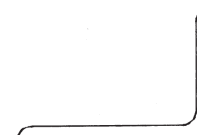

# Hurricane Protection

## 2023 HINGE

Part #	Color	Size
8659021	MF	21.67'
8659321	White	21.67'

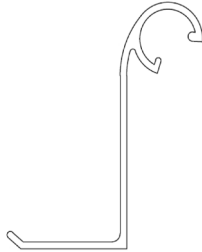

## BAH 1" B/O HINGE MF 21.67 6063T6

Part #	Color	Size
8653021	MF	21.67'
8653321	MF	21.67'

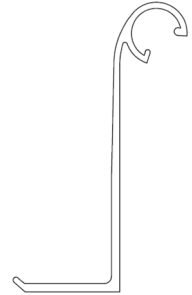

## 2023 COL/BAH JAMB

Part #	Color	Size
8667021	MF	1.5'
8667321	White	1.5'

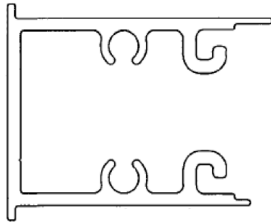

## 2023 JAMB SLIDE FAB

Part #	Color	Size
8668021	MF	21.5'
8668321	White	21.5'

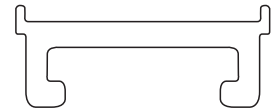

## 2023 BAHAMA MULL

Part #	Color	Size
8669021	MF	21.5'
8669321	White	21.5'

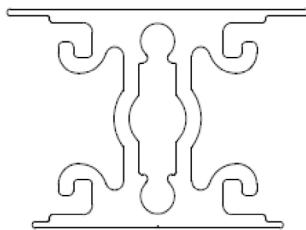

## 2023 BAH/COL HI-TEMP 1/2"X3/4" WASHER

Part #	Size
8685009	EA (REC washer)

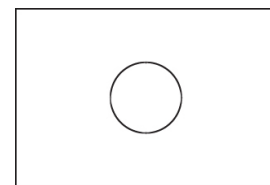

### NYLON BAHAMA ARM SPACER

Part #	Color	Size
8685010	Black	
8685011	White	

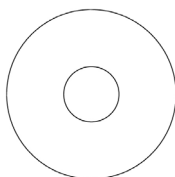

### Bahama Angle Clip

Part #
8677000



### Long Hi Temp End Cap Black

Part #	Type
8675000LGL	Left
8675001LGR	Right

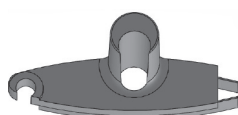

### UltraView Hi Temp Bushing

Part #	Type
8679000	Left
8679001	Right

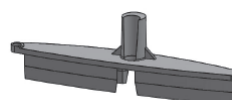

### FullView Short Bahama End Cap Hi Temp

Part #	Type
8675000	Left
8675001	Right

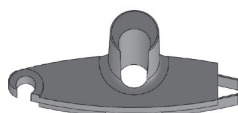

### UltraView Short Bahama Hi Temp Bushing

Part #	Type
8679002	Left
8679003	Right

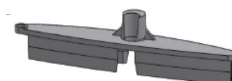

### 8" Z Bar

Part #
8680000

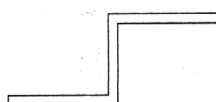

# Hurricane Protection

## AB86 1/4" Aluminum Hinge Rivet 300/Bag

### Part #

8686007



## #10 x 2 410 HT Blade Screw 1000/Box

### Part #

### Type

8685000

Right (Grey)

8685000LT

Reverse Thread (Black)

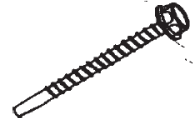

## #6 x 1/2" 410 Angle Screw 1000/Box

### Part #

8685001



## #14 x SS Jamb Screw 500/Bag

### Part #

### Type

8685002

Flat Square

8685007

Pan Square



## #14 x 3 SS Mull Screw 100/Bag

### Part #

### Type

8685003

Flat Square

8685008

Pan Square

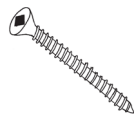

## 8" Bahama Rod Channel

### Part #

### Type

### Size

8681008

Mill

8'



## 6061 Locking Pins 3/8"

### Part #

### Type

### Size

8433008

Mill

8"



## 1/2" x 5/8" Colonial Wheel Bushing

### Part #

8407000



### E.A. Colonial 6" Hinge Pin

Part #

8686006



### Bahama/Colonial Hi-Temp Nylon Blade Washer

Part #

8685004



### Hold Back Channel .517 lb/ft

Part #

8682012

Type

Mill

Size

12.75'

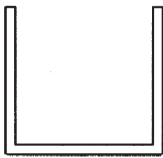

### Colonial Bullet & Clip

Part #

8678000

Type

Chrome

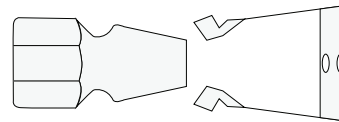

### 1/4" Tapered Tru Drive

Part #

2341001

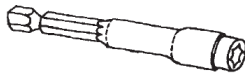

### 1/4"- 20 Thumb Screw

Part #

2504000



### Ring

Part #

2502000



### Large Camel Bracket

Part #

2488000

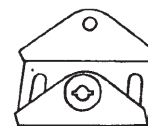

# Hurricane Protection

## U Bracket

**Part #**

2506000

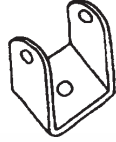

## 1/4 - 20 Nut

**Part #**

8686004

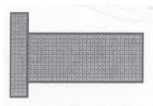

## 1" Serrated Tube

**Part #**

1402120

**Type**

Anodized

**Size**

20'



## Lock Pins

**Part #**

2492000



## 7/8" Serrated Tube

**Part #**

1400120

**Type**

Anodized

**Size**

20'



## #10 SS Thumb Screw Part

**Part #**

8681175

**Type**

Stainless Steel

**Size**

1.75"

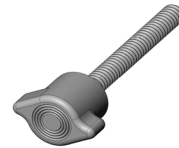

# Painted Angles

## 6063-T6

Part #	Length	Color	A	x	B	x	C	Wt./Ft.
1080320	20'	White	½"	x	½"	x	.062	.069
1084220	20'	Bronze	¾"	x	¾"	x	.062	.107
1084320	20'	White	¾"	x	¾"	x	.062	.107
1088220	20'	Bronze	1"	x	1"	x	.062	.144
1088320	20'	White	1"	x	1"	x	.062	.144
5012220	20'	Bronze	1"	x	1"	x	.125	.276
5012320	20'	White	1"	x	1"	x	.125	.276
5012620	20'	Ivory	1"	x	1"	x	.125	.276
1094224	24'	Bronze	2"	x	2"	x	.093	.436
1094324	24'	White	2"	x	2"	x	.093	.436
5032220	20'	Bronze	2"	x	2"	x	.125	.581
5032320	20'	White	2"	x	2"	x	.125	.581
5032620	20'	Ivory	2"	x	2"	x	.125	.581
1090220	20'	Bronze	1"	x	2"	x	.062	.218
1090320	20'	White	1"	x	2"	x	.062	.218
5056220	20'	Bronze	1"	x	2"	x	.093	.324
5056320	20'	White	1"	x	2"	x	.093	.324
5056620	20'	Ivory	1"	x	2"	x	.093	.324
5058220	20'	Bronze	1"	x	2"	x	.125	.431
5058320	20'	White	1"	x	2"	x	.125	.431
5058620	20'	Ivory	1"	x	2"	x	.125	.431
1092220	20'	Bronze	1"	x	3"	x	.062	.293
1092320	20'	White	1"	x	3"	x	.062	.293
5072220	20'	Bronze	1½"	x	3"	x	.090	.482
5072320	20'	White	1½"	x	3"	x	.090	.482
5072620	20'	Ivory	1½"	x	3"	x	.090	.482
5072820	20'	Beige	1½"	x	3"	x	.090	.482
5074220	20'	Bronze	2"	x	3"	x	.125	.731
5074320	20'	White	2"	x	3"	x	.125	.731
5074620	20'	Ivory	2"	x	3"	x	.125	.731
5074820	20'	Beige	2"	x	3"	x	.125	.731
5076220	20'	Bronze	2"	x	4"	x	.125	.881
5076320	20'	White	2"	x	4"	x	.125	.881
5076620	20'	Ivory	2"	x	4"	x	.125	.881
5076820	20'	Beige	2"	x	4"	x	.125	.881
5080220	20'	Bronze	2"	x	5"	x	.125	1.031
5080320	20'	White	2"	x	5"	x	.125	1.031
5080620	20'	Ivory	2"	x	5"	x	.125	1.031
5080820	20'	Beige	2"	x	5"	x	.125	1.031

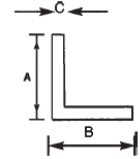

# Hurricane Protection

## Architectural Angles

### 6063-T5

Part #	Length	Color	A	x	B	x	C	Wt./Ft.
5000020	20'	Mill Finish	½"	x	½"	x	.062	.070
5002020	20'	Mill Finish	¾"	x	¾"	x	.062	.107
5004020	20'	Mill Finish	¾"	x	¾"	x	.125	.206
5010020	20'	Mill Finish	1"	x	1"	x	.062	.144
5012020	20'	Mill Finish	1"	x	1"	x	.125	.276
5015020	20'	Mill Finish	1"	x	1"	x	.250	.570
5016020	20'	Mill Finish	1¼"	x	1¼"	x	.125	.356
5020020	20'	Mill Finish	1½"	x	1½"	x	.062	.219
5022020	20'	Mill Finish	1½"	x	1½"	x	.125	.431
5024020	20'	Mill Finish	1½"	x	1½"	x	.188	.633
5028020	20'	Mill Finish	2"	x	2"	x	.062	.293
5032020	20'	Mill Finish	2"	x	2"	x	.125	.581
5034020	20'	Mill Finish	2"	x	2"	x	.188	.859
5036020	20'	Mill Finish	2"	x	2"	x	.250	1.124
5038020	20'	Mill Finish	3"	x	3"	x	.125	.881
5039020	20'	Mill Finish	3"	x	3"	x	.250	1.725
5040020	20'	Mill Finish	½"	x	1"	x	.125	.206
5050020	20'	Mill Finish	¾"	x	1½"	x	.125	.319
5052020	20'	Mill Finish	1"	x	1½"	x	.125	.356
5054020	20'	Mill Finish	1"	x	2"	x	.062	.218
5058020	20'	Mill Finish	1"	x	2"	x	.125	.431
5062020	20'	Mill Finish	1"	x	3"	x	.125	.582
5068024	24'	Mill Finish	1½"	x	2"	x	.125	.506
5074020	20'	Mill Finish	2"	x	3"	x	.125	.750
5076020	20'	Mill Finish	2"	x	4"	x	.125	.881
5080020	20'	Mill Finish	2"	x	5"	x	.125	1.031

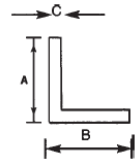

# Structural Angles

## 6061-T6

Part #	Length	Color	A	x	B	x	C	Wt./Ft.
5102025	25'	Mill Finish	1"	x	1"	x	.125	.280
5104025	25'	Mill Finish	1"	x	1"	x	.188	.406
5106025	25'	Mill Finish	1"	x	1"	x	.250	.514
5108025	25'	Mill Finish	1¼"	x	1¼"	x	.125	.343
5110025	25'	Mill Finish	1¼"	x	1¼"	x	.188	.522
5114025	25'	Mill Finish	1½"	x	1½"	x	.125	.440
5116025	25'	Mill Finish	1½"	x	1½"	x	.188	.640
5118025	25'	Mill Finish	1½"	x	1½"	x	.250	.830
5124025	25'	Mill Finish	1¾"	x	1¾"	x	.188	.744
5130025	25'	Mill Finish	2"	x	2"	x	.125	.588
5132025	25'	Mill Finish	2"	x	2"	x	.188	.870
5134025	25'	Mill Finish	2"	x	2"	x	.250	1.110
5136025	25'	Mill Finish	2"	x	2"	x	.375	1.606
5140025	25'	Mill Finish	2½"	x	2½"	x	.188	1.070
5142025	25'	Mill Finish	2½"	x	2½"	x	.250	1.404
5146025	25'	Mill Finish	3"	x	3"	x	.188	1.275
5148025	25'	Mill Finish	3"	x	3"	x	.250	1.730
5150025	25'	Mill Finish	3"	x	3"	x	.375	2.474
5160025	25'	Mill Finish	4"	x	4"	x	.250	2.350
5162025	25'	Mill Finish	4"	x	4"	x	.375	3.366
5166025	25'	Mill Finish	5"	x	5"	x	.375	4.237
5172025	25'	Mill Finish	6"	x	6"	x	.500	6.754
5189025	25'	Mill Finish	1½"	x	2½"	x	.250	1.110
5192025	25'	Mill Finish	2"	x	3"	x	.188	1.090
5196025	25'	Mill Finish	2"	x	3"	x	.375	2.046
5194025	25'	Mill Finish	2"	x	3"	x	.250	1.405
5202025	25'	Mill Finish	3"	x	3½"	x	.250	1.842
5208025	25'	Mill Finish	3"	x	4"	x	.250	1.988
5214025	25'	Mill Finish	3"	x	5"	x	.375	3.349
5218025	25'	Mill Finish	3½"	x	6"	x	.375	4.090
5220025	25'	Mill Finish	4"	x	6"	x	.375	4.237

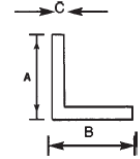

# Hurricane Protection

## Painted Tubes

### 6063-T6

Part #	Length	Color	A	x	B	x	C	Wt./Ft.
6672224	24.17'	Bronze	2"	x	2"	x	.093	.851
6672324	24.17'	White	2"	x	2"	x	.093	.851
6672624	24.17'	Ivory	2"	x	2"	x	.093	.851
6674224	24.17'	Bronze	2"	x	2"	x	.125	1.126
6674324	24.17'	White	2"	x	2"	x	.125	1.126
6674624	24.17'	Ivory	2"	x	2"	x	.125	1.126
6674824	24.17'	Beige	2"	x	2"	x	.125	1.126
1116224	24.17'	Bronze	3"	x	3"	x	.093	1.298
1116324	24.17'	White	3"	x	3"	x	.093	1.298
1118224	24.17'	Bronze	3"	x	3"	x	.125	1.726
1118324	24.17'	White	3"	x	3"	x	.125	1.726
1120224	24.17'	Bronze	4"	x	4"	x	.125	2.324
1120324	24.17'	White	4"	x	4"	x	.125	2.324
6738224	24.17'	Bronze	1"	x	2"	x	.062	.428
6738324	24.17'	White	1"	x	2"	x	.062	.428
6740224	24.17'	Bronze	1"	x	2"	x	.093	.633
6740324	24.17'	White	1"	x	2"	x	.093	.633
6740624	24.17'	Ivory	1"	x	2"	x	.093	.633
6742224	24.17'	Bronze	1"	x	2"	x	.125	.824
6742324	24.17'	White	1"	x	2"	x	.125	.824
6742624	24.17'	Ivory	1"	x	2"	x	.125	.824
6746224	24.17'	Bronze	1"	x	3"	x	.125	1.125
6746324	24.17'	White	1"	x	3"	x	.125	1.125
6748224	24.17'	Bronze	1"	x	4"	x	.125	1.426
6748324	24.17'	White	1"	x	4"	x	.125	1.426
6768224	24.17'	Bronze	2"	x	3"	x	.125	1.426
6768324	24.17'	White	2"	x	3"	x	.125	1.426
6768624	24.17'	Ivory	2"	x	3"	x	.125	1.426
6768824	24.17'	Beige	2"	x	3"	x	.125	1.426
6772224	24.17'	Bronze	2"	x	4"	x	.125	1.724
6772324	24.17'	White	2"	x	4"	x	.125	1.724
6772824	24.17'	Beige	2"	x	4"	x	.125	1.724
1122224	24.17'	Bronze	2"	x	5"	x	.093	1.520
1122324	24.17'	White	2"	x	5"	x	.093	1.520
6778224	24.17'	Bronze	2"	x	5"	x	.125	2.025
6778324	24.17'	White	2"	x	5"	x	.125	2.025
6780224	24.17'	Bronze	2"	x	6"	x	.125	2.326
6780324	24.17'	White	2"	x	6"	x	.125	2.326

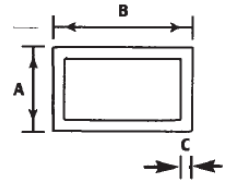

# Rectangular Tubes

## 6063-T5

Part #	Length	Color	A	x	B	x	C	Wt./Ft.
6730024	24'	Mill Finish	½"	x	1"	x	.093	.293
6732024	24'	Mill Finish	¾"	x	1½"	x	.125	.600
6736024	24'	Mill Finish	1"	x	1½"	x	.125	.676
6738024	24'	Mill Finish	1"	x	2"	x	.062	.428
6740024	24'	Mill Finish	1"	x	2"	x	.093	.633
6742024	24'	Mill Finish	1"	x	2"	x	.125	.824
6746024	24'	Mill Finish	1"	x	3"	x	.125	1.125
6748024	24'	Mill Finish	1"	x	4"	x	.125	1.426
6750024	24'	Mill Finish	1¼"	x	2½"	x	.125	1.050
6752024	24'	Mill Finish	1½"	x	2"	x	.125	.976
6754024	24'	Mill Finish	1½"	x	3"	x	.125	1.272
6760024	24'	Mill Finish	1¾"	x	3"	x	.125	1.350
6764024	24'	Mill Finish	1¾"	x	4"	x	.125	1.650
6768024	24'	Mill Finish	2"	x	3"	x	.125	1.426
6772024	24'	Mill Finish	2"	x	4"	x	.125	1.724
6778024	24'	Mill Finish	2"	x	5"	x	.125	2.025
6780024	24'	Mill Finish	2"	x	6"	x	.125	2.327
6782024	24'	Mill Finish	2"	x	8"	x	.125	2.962
6783024	24'	Mill Finish	3"	x	4"	x	.125	2.074

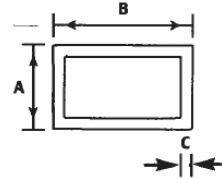

## 6061-T6

Part #	Length	Color	A	x	B	x	C	Wt./Ft.
6774024	24'	Mill Finish	2"	x	4"	x	.250	3.408
6781124	24'	Mill Finish	2"	x	6"	x	.250	4.652
6788028	28'	Mill Finish	4"	x	6"	x	.250	5.700
6790028	28'	Mill Finish	4"	x	8"	x	.250	6.900

## 6005-T5

Part #	Length	Color	A	x	B	x	C	Wt./Ft.
6741024	24'	Mill Finish	1"	x	2"	x	.125	.811
6781024	24'	Mill Finish	2"	x	10"	x	.190	5.244

# Hurricane Protection

## Square Tubes

### 6063-T5

Part #	Length	Color	A	x	B	x	C	Wt./Ft.
6620024	24'	Mill Finish	½"	x	½"	x	.062	.131
6628024	24'	Mill Finish	¾"	x	¾"	x	.062	.206
6631924	24'	Mill Finish	¾"	x	¾"	x	.093	.293
6632024	24'	Mill Finish	¾"	x	¾"	x	.125	.374
6638024	24'	Mill Finish	1"	x	1"	x	.062	.278
6642024	24'	Mill Finish	1"	x	1"	x	.090	.405
6644024	24'	Mill Finish	1"	x	1"	x	.125	.526
6648024	24'	Mill Finish	1¼"	x	1¼"	x	.062	.353
6650024	24'	Mill Finish	1¼"	x	1¼"	x	.093	.516
6654024	24'	Mill Finish	1¼"	x	1¼"	x	.125	.675
6656024	24'	Mill Finish	1½"	x	1½"	x	.062	.430
6658024	24'	Mill Finish	1½"	x	1½"	x	.093	.632
6660024	24'	Mill Finish	1½"	x	1½"	x	.125	.824
6664024	24'	Mill Finish	1¾"	x	1¾"	x	.125	.975
6666024	24'	Mill Finish	2"	x	2"	x	.062	.604
6672024	24'	Mill Finish	2"	x	2"	x	.093	.851
6674024	24'	Mill Finish	2"	x	2"	x	.125	1.126
6676024	24'	Mill Finish	2"	x	2"	x	.188	1.627
6678024	24'	Mill Finish	2"	x	2"	x	.250	2.100
6682024	24'	Mill Finish	2½"	x	2½"	x	.125	1.425
6684024	24'	Mill Finish	3"	x	3"	x	.093	1.298
6686024	24'	Mill Finish	3"	x	3"	x	.125	1.760
6690024	24'	Mill Finish	4"	x	4"	x	.125	2.324
6694024	24'	Mill Finish	5"	x	5"	x	.125	2.925
6696024	24'	Mill Finish	6"	x	6"	x	.125	3.525
6698024	24'	Mill Finish	8"	x	8"	x	.188	7.050

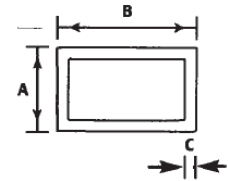

### 6061-T6

Part #	Length	Color	A	x	B	x	C	Wt./Ft.
6569024	24'	Mill Finish	1"	x	1"	x	.125	.524
6570024	24'	Mill Finish	1½"	x	1½"	x	.125	.824
6572024	24'	Mill Finish	2"	x	2"	x	.093	.851
6576024	24'	Mill Finish	2"	x	2"	x	.125	1.126
6580024	24'	Mill Finish	2"	x	2"	x	.250	2.100
6586024	24'	Mill Finish	3"	x	3"	x	.250	3.300
6588024	24'	Mill Finish	4"	x	4"	x	.250	4.500
6592024	24'	Mill Finish	6"	x	6"	x	.250	7.100

## Anchors

### Lead Anchor

Part #	Type
2556000	Solid Set
2558000	Brass Bushing (not code approved)



### Jack Nut

Part #
2434000



### Jack Nut Tool

Part #
2576000

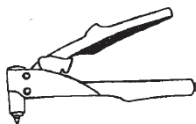

### Drive Nail

Part #
2560000



### Brass Bushing

Part #
2580000



### Tamp Setter

Part #
2578000



## Concrete Screws & Screw Cap Covers

### ITW Tapcons Hex Head

Size	Bronze	White
1/4 x 1 3/4	2570200	2570300
1/4 x 2 1/4	2572200	2572300
1/4 x 3 1/4		2574300

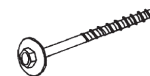

### Small Screw Cap Cover

Bronze	White	Ivory	Beige
2565200*	2565300*	2565600*	2565800*

\* Special Order

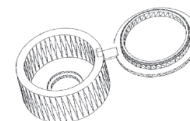

### Large Screw Cap Cover

Bronze	White	Ivory	Beige
2566200*	2566300*	2566600*	2566800*

\* Special Order

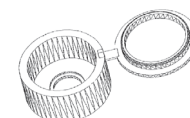

# Hurricane Protection

## Rivets, Lags & Studs

### Stud Caps 3/4"

Part #	Color
2587000	White



### 1/4" 20 Sidewalk Bolts

Part #	Size
2374000	1/2"
2376000	1"
2377000	2"

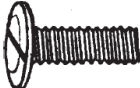

### 1/4" SS Hangerbolts

Part #	Size
LN04170	4 1/2"
LN04500	8"



### Stud Caps 1 1/8"

Part #	Color
LN04240	White
LN04245	Bronze



### 1/4" 20 x 1" Track Bolts

Part #	Color
2406000	Stainless Steel

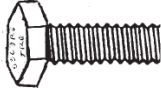

### Pop Rivets

Part #	Color	Size
26803000	White	1/8"



## Screws

### Machine Screws Truss Head

Part #	Size	Color
2370000	1/4 -20 x 1	Stainless Steel
2370000	1/4 -20 x 1 1/2	Stainless Steel
2370000	1/4 -20 x 2	Stainless Steel
2370000	1/4 -20 x 2 1/2	Stainless Steel



### EA Male Bolt & Bolt Driver

Part #	Description
8422250	EA MALE BOLT 410SS COATED 2.5"
8422350	EA MALE BOLT 410SS COATED 3.5"
8422450	EA MALE BOLT 410SS COATED 4.5"
8422762	EA MALE BOLT 410SS COATED 7.625"
8422000	EA MALE BOLT DRIVER 3/16 GREEN

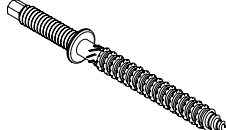

### EA Female Bolt & Hex Driver

Part #	Description
8423350	EA FEMALE BOLT 410SS COATED 3.5"
8423450	EA FEMALE BOLT 410SS COATED 4.5"
8423762	EA FEMALE BOLT 410SS COATED 7.625"
8423000	EA FEMALE HEX DRIVER 1/4 HEX PURPLE



### EA Bolt Drill Bits

Part #	Description
8421002	7/16 Female EA Combo bit housing only
8421005	7/32 X 5" Masonry Pilot Bit
8421009	7/32 X 9" Masonry Pilot Bit
8421000	EA Female Bolt Combo Bit Short
8421001	EA Female Bolt Combo Bit Long

## Self Drilling Screws Hex Head T&C-Ultracote Carbon Steel

Size	Bronze	White
#8 x 1/2	TC2124200	TC2124300
#8 x 9/16	TC2128200	TC2128300
#10 x 3/4	TC2134200	TC2134300
#10 x 1	TC2138200	TC2138300
#10 x 1 1/2	TC2142200	TC2142300
#10 x 2	TC2146200	TC2146300
#12 x 3/4	TC2135200	TC2135300
#14 x 3/4	TC2158200	TC2158300
#14 x 1	TC2160200	TC2160300
#14 x 2	TC2154200	TC2154300



## T&C-Ultracote 410 Stainless Steel by MillFast

Size	Bronze	White	Silver
9/16 x #8 SDS	21282PCSS4	21283PCSS4	
3/4 x #10 SDS	21332PCSS4	21333PCSS4	
3/4 x #12 SDS	21352PCSS4	21353PCSS4	
3/4 x #14 SDS	21582PCSS4	21583PCSS4	
1 x #14 SDS	21602PCSS4	21603PCSS4	
2 x #14 SDS	21542PCSS4	21543PCSS4	
1/2 x #8 SMS	22142PCSS4	22143PCSS4	
1 x #10 SMS	21722PCSS4	21723PCSS4	
1 1/2 x #10 SMS	21762PCSS4	21763PCSS4	
2 x #10 SMS	21802PCSS4	21803PCSS4	
3 x #10 SMS	21842PCSS4	21843PCSS4	
4 x #10 SMS	21882PCSS4	21883PCSS4	
1 3/4" C.SCR	25702PCSS4	25703PCSS4	
2 1/4" C.SCR	25722PCSS4	25723PCSS4	
3" C.SCR	25742PCSS4	25743PCSS4	
4" x 3/8 C.SCR	2571005SS4	2571004SS4	
5" x 3/8 C.SCR	2571007SS4	2571006SS4	
7" x 3/8 C.SCR	2571011SS4	2571010SS4	
1 x #14 SDS		21603PCSS4	
9/16 x #8 SDS			21281PCSS4
3/4 x #10 SDS			21331PCSS4
3/4 x #12 SDS			21351PCSS4
3/4 x #14 SDS			21581PCSS4
2 x #14 SDS			21541PCSS4
1/2 x #8 SMS			22141PCSS4
1 x #10 SMS			21721PCSS4
1 1/2 x #10 SMS			21761PCSS4
2 x #10 SMS			21801PCSS4
3 x #10 SMS			21841PCSS4
4 x #10 SMS			21881PCSS4
1 3/4" C.SCR			25701PCSS4
2 1/4" C.SCR			25721PCSS4
3" C.SCR			25741PCSS4
4" x 3/8 C.SCR			2571008SS4
5" x 3/8 C.SCR			2571009SS4
7" x 3/8 C.SCR			2571012SS4



# Hurricane Protection

## Washers

### Flat Washers Aluminum

Part #	Size
2438000	3/4 x 1/4
2440000	3/4 x #10



### Fender Washers

Part #	Size
2446000	1 1/2"

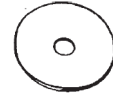

### Keyhole Washers

Part #
2442000



### Flat Nylon Washers

Part #
2444000



### Neoprene Washers

Part #
2436000



## Drill Bits

### Drill Bits

Part #	Size	Description
2302000	3/64"	Short
2300000	1/16"	Short
2304000	3/32"	Long
2306000	7/64"	Long
2308000	1/8"	Long
2310000	9/64"	Long
2312000	5/32"	Long
2314000	11/64"	Long
2316000	3/16"	Long
2318000	13/64"	Long
2320000	7/32"	Long
2322000	1/4"	Long
2324000	9/32"	Long
2326000	7/16"	Long



### Masonry Drill Bits

Part #	Size	Description
2328000	3/16"	Short 4"
2330000	3/16"	Long 6"
2332000	1/4"	Short 4"
2334000	1/4"	Long 6"



### Combination Drill Bits

Part #	Size	Description
2336000	1/2"	Adjustable



# Drivers

## Magnetic Tip Holders

**Part #**

2338000

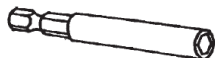

## Hex Drivers

**Part #**

**Size**

- 2344000
- 2346000
- 2348000
- 2350000

- 1/4"
- 5/16"
- 3/8"
- 7/16"

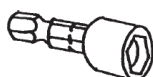

Additional drivers available on page 56 (T&C-UltraDrivers)

## Extensions

**Part #**

**Size**

- 2360000
- 2362000
- 2364000

- 2"
- 4"
- 6"



## Hex Bit Tapered

**Part #**

**Size**

2341000

1/4"



## Panelmates For Wood Or Concrete

**Part #**

**Description**

- 2592000
- 2593000

- Male
- Female

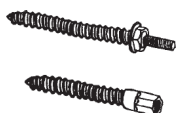

Check local branch for various sizes and styles

## Tapered Tru Drivers

**Part #**

**Size**

2341001

1/4"

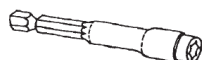

## #2 Phillips Tips

**Part #**

2340000



## Sockets

**Part #**

**Size**

- 2352000
- 2354000
- 2356000
- 2358000

- 1/4"
- 5/16"
- 3/8"
- 7/16"



## Wing Nut Drivers

**Part #**

- 2596000 (No Handle)
- 2594000 (Handle)

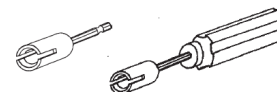

## Sidewalk Bolt Bits

**Part #**

**Description**

2351000

Straight Slot



## Panelmates Drivers

**Part #**

**Size**

2337003

3/8"



# Hurricane Protection

## Eyewall Armor Fabric and Clip

### EA Hurricane Fabric

Part #	Description
PEAFABEA	P-EA Hurricane Fabric 96" x 75'
PEAFABLF	P-EA Hurricane Fabric LF
PEAFABSF	P-EA Hurricane Fabric SF

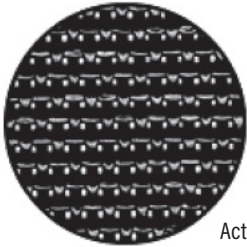

Actual Color: White

### EA Fabric Clip 100/Box

Part #	Description
EAFABCPN18	EA FAB Clip Natural 2018 Each

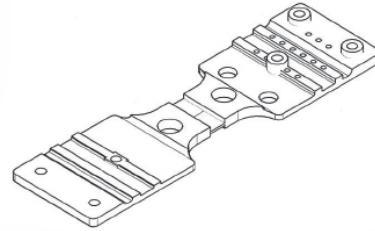

### EA Fabric 14" x 1/2" Zinc SMS Screw

Part #	Quantity
EAFABSCB18	300 per bag





